

Noise Figure Analyzers NFA Series

Performance Verification and Calibration Guide



Agilent Technologies

Manufacturing Part Number: N8972-90083

December 2001

© Copyright 2001 Agilent Technologies

Safety Notices

The information contained in this document is subject to change without notice.

Agilent Technologies makes no warranty of any kind with regard to this material, including but not limited to, the implied warranties of merchantability and fitness for a particular purpose. Agilent Technologies shall not be liable for errors contained herein or for incidental or consequential damages in connection with the furnishing, performance, or use of this material.

The following safety symbols are used throughout this manual. Familiarize yourself with the symbols and their meaning before operating this instrument.

WARNING

***Warning* denotes a hazard. It calls attention to a procedure which, if not correctly performed or adhered to, could result in injury or loss of life. Do not proceed beyond a warning note until the indicated conditions are fully understood and met.**

CAUTION

Caution denotes a hazard. It calls attention to a procedure that, if not correctly performed or adhered to, could result in damage to or destruction of the instrument. Do not proceed beyond a caution sign until the indicated conditions are fully understood and met.

NOTE

Note calls out special information for the user's attention. It provides operational information or additional instructions of which the user should be aware.

General Safety Information

The following general safety precautions must be observed during all phases of operation, service, and repair of this instrument. Failure to comply with these precautions or with specific warnings elsewhere in this manual violates safety standards of design, manufacture, and intended use of the instrument. Agilent Technologies assumes no liability for the customer's failure to comply with these requirements.

DO NOT operate the product in an explosive atmosphere or in the presence of flammable gasses or fumes.

DO NOT use repaired fuses or short-circuited fuseholders: For continued protection against fire, replace the line fuse(s) only with fuse(s) of the same voltage and current rating and type. Disconnect product from mains supply voltage before replacing fuse.

DO NOT perform procedures involving cover or shield removal unless you are qualified to do so: Operating personnel must not remove equipment covers or shields. Procedures involving the removal of covers and shields are for use by service-trained personnel only.

DO NOT service or adjust alone: Under certain conditions, dangerous voltages may exist even with the equipment switched off. To avoid dangerous electrical shock, service personnel must not attempt internal service or adjustment unless another person, capable of rendering first aid and resuscitation, is present.

DO NOT operate damaged equipment: Whenever it is possible that the safety protection features built into this product have been impaired, either through physical damage, excessive moisture, or any other reason, REMOVE POWER and do not use the product until safe operation can be verified by service-trained personnel. If necessary, return the product to an Agilent Technologies Sales and Service Office for service and repair to ensure the safety features are maintained.

DO NOT substitute parts or modify equipment: Because of the danger of introducing additional hazards, do not install substitute parts or perform any unauthorized modification to the product. Return the product to an Agilent Technologies Sales and Service Office for service and repair to ensure the safety features are maintained.

WARNING





This is a Safety Class 1 Product (provided with a protective earthing ground incorporated in the power cord). The mains plug shall only be inserted in a socket outlet provided with a protected earth contact. Any interruption of the protective conductor inside or outside of the product is likely to make the product dangerous. Intentional interruption is prohibited.





WARNING

If this product is not used as specified, the protection provided by the equipment could be impaired. This product must be used in a normal condition (in which all means for protection are intact) only.

Safety Symbols

The following symbols on the instrument and in the manual indicate precautions which must be taken to maintain safe operation of the instrument.

	The Instruction Documentation Symbol. The product is marked with this symbol when it is necessary for the user to refer to the instructions in the supplied documentation.
	This symbol indicates that the input power required is Alternating current (AC).
	This symbol indicates the position of the operating switch for 'On' mode
	This symbol indicates the position of the operating switch for 'Stand-by' mode. Note, the instrument is NOT isolated from the mains when the switch is in this position. To isolate the instrument, the mains coupler (mains input cord) should be removed from the power supply.

	<p>This symbol indicates that a device, or part of a device, may be susceptible to electrostatic discharges (ESD) which can result in damage to the product. Observe ESD precautions given on the product, or its user documentation, when handling equipment bearing this mark.</p>
	<p>The CE mark shows that the product complies with all relevant European Legal Directives.</p>
	<p>The C-Tick mark is a registered trademark of the Australian Communications Authority. This signifies compliance with the Australian EMC Framework Regulations under the terms of the Radio communications Act of 1992.</p>
<p>ISM 1-A</p>	<p>This is a symbol of an Industrial, Scientific, and Medical Group 1 Class A product.</p>
<p>ICES/NMB-001</p>	<p>This ISM device complies with Canadian ICES-001. Cet appareil ISM est conforme à la norme NMB-001 du Canada.</p>
	<p>The CSA mark is a registered trademark of the Canadian Standards Association, and indicates compliance to the standards laid out by them.</p>

Trademark Acknowledgement

Microsoft® is a US registered trademark of Microsoft Corp.

Warranty

This Agilent Technologies instrument product is warranted against defects in material and workmanship for a period of three years from date of shipment. During the warranty period, Agilent Technologies Company will, at its option, either repair or replace products which prove to be defective.

For warranty service or repair, this product must be returned to a service facility designated by Agilent Technologies. Buyer shall prepay shipping charges to Agilent Technologies and Agilent Technologies shall pay shipping charges to return the product to Buyer. However, Buyer shall pay all shipping charges, duties, and taxes for products returned to Agilent Technologies from another country.

Agilent Technologies warrants that its software and firmware designated by Agilent Technologies for use with an instrument will execute its programming instructions when properly installed on that instrument. Agilent Technologies does not warrant that the operation of the instrument, or software, or firmware will be uninterrupted or error-free.

LIMITATION OF WARRANTY

The foregoing warranty shall not apply to defects resulting from improper or inadequate maintenance by Buyer, Buyer-supplied software or interfacing, unauthorized modification or misuse, operation outside of the environmental specifications for the product, or improper site preparation or maintenance.

NO OTHER WARRANTY IS EXPRESSED OR IMPLIED. AGILENT TECHNOLOGIES SPECIFICALLY DISCLAIMS THE IMPLIED WARRANTIES OF MERCHANTABILITY AND FITNESS FOR A PARTICULAR PURPOSE.

EXCLUSIVE REMEDIES

THE REMEDIES PROVIDED HEREIN ARE BUYER'S SOLE AND EXCLUSIVE REMEDIES. AGILENT TECHNOLOGIES SHALL NOT BE LIABLE FOR ANY DIRECT, INDIRECT, SPECIAL, INCIDENTAL, OR CONSEQUENTIAL DAMAGES, WHETHER BASED ON CONTRACT, TORT, OR ANY OTHER LEGAL THEORY.

Where to Find the Latest Information

Documentation is updated periodically. For the latest information about the NFA Noise Figure Analyzer Series, including firmware upgrades and application information, please visit the following Internet URL:

<http://www.agilent.com/find/nf/>

Lifting and Carrying

Use the handle for lifting or carrying the unit.

Before attempting to lift or carry the instrument consider the following basic lifting techniques to help avoid personal injury.

Using one arm to lift instrument.

- BRACE your body with the opposite arm, if possible.
- Reach for the instrument - bend your knees and waist, and keep your back straight.
- GRASP the instrument firmly - using the handle.
- LIFT with your legs, using the free arm for balance.
- KEEP your shoulders level - switch hands regularly.

Electromagnetic Compatibility

This product conforms with the protection requirements of European Council Directive 89/336/EEC for Electromagnetic Compatibility (EMC).

The conformity assessment requirements have been met using the technical Construction file route to compliance, using EMC test specifications EN 55011:1991 (Group 1, Class A) and EN 50082-1:1992.

In order to preserve the EMC performance of the product, any cable which becomes worn or damaged must be replaced with the same type and specification.

See the Declaration of Conformities on page ix, page x, page xi, page xii.

Radio-Frequency Electromagnetic Field Immunity

When a 3 Vm-1 radio-frequency electromagnetic field is applied to the Noise Figure Analyzer according to IEC 61000-4-3:1995, degradation of performance may be observed. When the frequency of the incident field matches the frequency of a measured noise figure or gain, the values displayed will deviate from those expected. This phenomenon will only affect that specific frequency, and the Analyzer will continue to perform to specification at all other frequency sample points.

The Noise Figure Analyzer may be unable to calibrate a chosen frequency sample point, if the frequency matches that of an incident electromagnetic field.

Declaration of Conformity — N8972A

DECLARATION OF CONFORMITY

According to ISO/IEC Guide 22 and CEN/CENELEC EN45014

Manufacturer's Name: Agilent Technologies UK Ltd.
Manufacturer's Address: Electronic Products Solutions Group - Queensferry
South Queensferry
West Lothian, EH30 9TG
Scotland, United Kingdom

Declares that the product

Product Name: Noise Figure Analyzer
Model Number: N8972A
Product Options: This declaration covers all options of the above product as detailed in TCF A-5951-9852-02.

EMC:

Conforms with the protection requirements of European Council Directive 89/336/EEC on the approximation of the laws of the member states relating to electromagnetic compatibility, against EMC test specifications EN 55011:1991 (Group 1, Class A) and EN 50082-1:1992.

As Detailed in: Electromagnetic Compatibility (EMC)
Technical Construction File (TCF) No. A-5951-9852-02.

Assessed by: DTI Appointed Competent Body
EMC Test Centre,
GEC-Marconi Avionics Ltd.,
Maxwell Building,
Donibristle Industrial Park,
Hillend,
Dunfermline
KY11 9LB
Scotland, United Kingdom

Technical Report Number:6893/2201/CBR, dated 23 September 1997

Safety:

The product conforms to the following safety standards:

IEC 61010-1(1990) +A1(1992) +A2(1995) / EN 61010-1:1993
IEC 60825-1(1993) / EN 60825-1:1994
Canada / CSA-C22.2 No. 1010.1-93

The product herewith complies with the requirements of the Low Voltage Directive 73/23/EEC, and carries the CE mark accordingly.

South Queensferry, Scotland.

24 March 2000

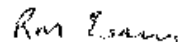

R.M. Evans / Quality Manager

For further information, please contact your local Agilent Technologies sales office, agent, or distributor.

Declaration of Conformity — N8973A

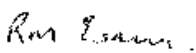
DECLARATION OF CONFORMITY		
According to ISO/IEC Guide 22 and CEN/CENELEC EN45014		
Manufacturer's Name:	Agilent Technologies UK Ltd.	
Manufacturer's Address:	Electronic Products Solutions Group - Queensferry South Queensferry West Lothian, EH30 9TG Scotland, United Kingdom	
Declares that the product		
Product Name:	Noise Figure Analyzer	
Model Number:	N8973A	
Product Options:	This declaration covers all options of the above product as detailed in TCF A-5961-9852-02.	
EMC:		
Conforms with the protection requirements of European Council Directive 89/336/EEC on the approximation of the laws of the member states relating to electromagnetic compatibility, against EMC test specifications EN 55011:1991 (Group 1, Class A) and EN 50082-1:1992.		
As Detailed in:	Electromagnetic Compatibility (EMC) Technical Construction File (TCF) No. A-5961-9852-02.	
Assessed by:	DTI Appointed Competent Body EMC Test Centre, GEC-Marconi Avionics Ltd., Maxwell Building, Donibristle Industrial Park, Hillend, Dundfermline KY11 9LB Scotland, United Kingdom	
Technical Report Number:6898/2201/CBR, dated 23 September 1997		
Safety:		
The product conforms to the following safety standards:		
	IEC 61010-1(1990) + A1(1992) + A2(1996) / EN 61010-1:1993 IEC 60825-1(1993) / EN 60825-1:1994 Canada / CSA-C22.2 No. 1010.1-93	
The product herewith complies with the requirements of the Low Voltage Directive 73/23/EEC, and carries the CE mark accordingly.		
<i>South Queensferry, Scotland.</i>	<i>24 March 2000</i>	
		<i>R.M. Evans / Quality Manager</i>
For further information, please contact your local Agilent Technologies sales office, agent, or distributor.		

Declaration of Conformity — N8974A

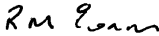
DECLARATION OF CONFORMITY	
According to ISO/IEC Guide 22 and CEN/CENELEC EN45014	
Manufacturer's Name:	Agilent Technologies UK Limited
Manufacturer's Address:	Electronic Products & Solutions Group - Queensferry South Queensferry West Lothian, EH30 9TG Scotland, United Kingdom
Declares that the product	
Product Name:	NFA Series Noise Figure Analyzer
Model Number:	N8974A
Product Options:	This declaration covers all options of the above product as detailed in TCF A-5951-9852-02.
EMC:	
Conforms with the protection requirements of European Council Directive 89/336/EEC on the approximation of the laws of the member states relating to electromagnetic compatibility, against EMC test specifications EN 55011:1991 (Group 1, Class A) and EN 50082-1:1992.	
As Detailed in:	Electromagnetic Compatibility (EMC) Technical Construction File (TCF) No. A-5951-9852-02.
Assessed by:	DTI Appointed Competent Body EMC Test Centre, GEC-Marconi Avionics Ltd., Maxwell Building, Donibristle Industrial Park, Hillend, Dunfermline KY11 9LB Scotland, United Kingdom
Technical Report Number:6893/2201/CBR, dated 23 September 1997	
Safety:	
The product conforms to the following safety standards:	
IEC 61010-1(1990) +A1(1992) +A2(1995) / EN 61010-1:1993 IEC 60825-1(1993) / EN 60825-1:1994 Canada / CSA-C22.2 No. 1010.1-93	
The product herewith complies with the requirements of the Low Voltage Directive 73/23/EEC, and carries the CE mark accordingly.	
South Queensferry, Scotland.	29 January 2001
	
	R.M. Evans - Manufacturing Engineering Manager
For further information, please contact your local Agilent Technologies sales office, agent, or distributor.	

Declaration of Conformity — N8975A

DECLARATION OF CONFORMITY	
According to ISO/IEC Guide 22 and CEN/CENELEC EN45014	
Manufacturer's Name:	Agilent Technologies UK Limited
Manufacturer's Address:	Electronic Products & Solutions Group - Queensferry South Queensferry West Lothian, EH30 9TG Scotland, United Kingdom
Declares that the product	
Product Name:	NFA Series Noise Figure Analyzer
Model Number:	N8975A
Product Options:	This declaration covers all options of the above product as detailed in TCF A-5951-9852-02.
EMC:	
Conforms with the protection requirements of European Council Directive 89/336/EEC on the approximation of the laws of the member states relating to electromagnetic compatibility, against EMC test specifications EN 55011:1991 (Group 1, Class A) and EN 50082-1:1992.	
As Detailed in:	Electromagnetic Compatibility (EMC) Technical Construction File (TCF) No. A-5951-9852-02.
Assessed by:	DTI Appointed Competent Body EMC Test Centre, GEC-Marconi Avionics Ltd., Maxwell Building, Donibristle Industrial Park, Hillend, Dunfermline KY11 9LB Scotland, United Kingdom
Technical Report Number:6893/2201/CBR, dated 23 September 1997	
Safety:	
The product conforms to the following safety standards:	
IEC 61010-1(1990) +A1(1992) +A2(1995) / EN 61010-1:1993 IEC 60825-1(1993) / EN 60825-1:1994 Canada / CSA-C22.2 No. 1010.1-93	
The product herewith complies with the requirements of the Low Voltage Directive 73/23/EEC, and carries the CE mark accordingly.	
<i>South Queensferry, Scotland.</i>	<i>29 January 2001</i>
	<i>R.M. Evans</i>
	R.M. Evans - Manufacturing Engineering Manager
For further information, please contact your local Agilent Technologies sales office, agent, or distributor.	

Contents

1. Preparing for Calibration and Performance Verification Test

Purpose of Tests	2
Calibration Cycle	3
Before You Start	4
Recording the Test Results	5
Recommended Test Equipment	6
Performance Verification and Adjustment Procedures	10

2. Test Descriptions

10 MHz Out Frequency Reference Accuracy	12
Test Description	12
Test Specification	12
Related Adjustment	12
Required Test Equipment	13
Test Setup	13
Test Procedure	14
10 MHz Out Frequency Reference Adjustment	18
Test Description	18
Required Test Equipment	18
Test Setup	19
Test Procedure	19
Input VSWR	22
Test Description	22
VSWR Test Specification	24
Related Adjustments	24
Required Test Equipment	24
Test Setup	26
Test Procedure	26

Contents

Frequency Accuracy	38
Test Description	38
Test Specification	38
Related Adjustment	39
Required Test Equipment.....	39
Test Setup	40
Test Procedure.....	40
Noise Source Supply Accuracy	52
Test Description	52
Test Specification	52
Related Adjustment	52
Required Test Equipment.....	52
Test Setup	53
Test Procedure.....	53
Noise Figure Range and Accuracy.....	55
Test Description	55
Test Specification	55
Related Adjustment	56
Required Test Equipment.....	56
Test Setup	57
Test Procedure.....	57
Gain Measurement Uncertainty	64
Test Description	64
Test Specification	65
Related Adjustment	65
Required Test Equipment.....	66
Test Setup	66
Test Procedure.....	67
Instrument Noise Figure	73
Test Description	73

Contents

Test Specification	73
Related Adjustment	76
Required Test Equipment	76
Test Setup	77
Test Procedure	78
Measurement Jitter	83
Test Description	83
Test Specification	83
Related Adjustment	83
Required Test Equipment	84
Test Setup	84
Test Procedure	85
3. Technical Specifications	
Frequency	90
Noise Figure and Gain	92
RF Input	96
Measurement	98
Display	100
Display units	100
Connectivity	101
General	101
Noise Source Drive Output	101
General Specifications	102
A. Model N8972A: Test Records	
10MHz Out Frequency Reference Accuracy Test Record	106
Input VSWR Test Record	107

Contents

Frequency Accuracy Test Record.	108
Noise Source Supply Accuracy Test Record	109
Noise Figure Range and Accuracy Test Record	110
Results: 4.5 - 6.5dB Noise Source ENR	110
Results: 14 - 17dB Noise Source ENR	111
Results: 20 - 22dB Noise Source ENR	112
Gain Measurement Uncertainty Test Record.	113
Instrument Noise Figure Test Record.	114
Measurement Jitter Test Record	115
 B. Model N8973A: Test Records	
10MHz Out Frequency Reference Accuracy Test Record.	118
Input VSWR Test Record	119
Frequency Accuracy Test Record.	120
Noise Source Supply Accuracy Test Record	121
Noise Figure Range and Accuracy Test Record	122
Results: 4.5 - 6.5dB Noise Source ENR	122
Results: 14 - 17dB Noise Source ENR	123
Results: 20 - 22dB Noise Source ENR	124
Gain Measurement Uncertainty Test Record.	125
Instrument Noise Figure Test Record.	126
Measurement Jitter Test Record	127
 C. Model N8974A: Test Records	
10MHz Out Frequency Reference Accuracy Test Record.	130
Input VSWR Test Record	131

Contents

Frequency Accuracy Test Record	132
Noise Source Supply Accuracy Test Record	133
Noise Figure Range and Accuracy Test Record	134
Results: 4.5 - 6.5dB Noise Source ENR.	134
Results: 14 - 17dB Noise Source ENR.	135
Results: 20 - 22dB Noise Source ENR.	136
Gain Measurement Uncertainty Test Record	137
Instrument Noise Figure Test Record	138
Measurement Jitter Test Record	139

D. Model N8975A: Test Records

10MHz Out Frequency Reference Accuracy Test Record	142
Input VSWR Test Record	143
Frequency Accuracy Test Record	144
Noise Source Supply Accuracy Test Record	146
Noise Figure Range and Accuracy Test Record	147
Results: 4.5 - 6.5dB Noise Source ENR.	147
Results: 14 - 17dB Noise Source ENR.	148
Results: 20 - 22dB Noise Source ENR.	149
Gain Measurement Uncertainty Test Record	150
Instrument Noise Figure Test Record	151
Measurement Jitter Test Record	153

E. Caring for Connectors

Introduction	156
Connector Part Numbers	156
Handling and Storage	156

Contents

Visual Inspection	157
Obvious Defects and Damage	157
Mating Plane Surfaces	157
Precision 7 mm Connectors	158
Sexed Connectors	159
Cleaning	161
Compressed Air	161
Cleaning Alcohol	161
Precision 7 mm Connectors	162
Cleaning Interior Surfaces	163
Drying Connectors	164
Mechanical Inspection: Connector Gages	165
Mechanical Specifications	166
Precision 7mm Connectors	166
Sexed Connectors	167
50 Ohm Type-N Connectors	167
75 Ohm Type-N Connectors	168
Using Connector Gages	169
Inspecting and Cleaning the Gage	169
Zeroing the Gage	169
Making Connections.	172
Align Connectors Carefully	172
To Make a Preliminary Connection	173
Final Connection Using a Torque Wrench.	174
Disconnection	175
Adapters	177
Principles of Microwave Connector Care	179

Contents

Contents

1**Preparing for Calibration and
Performance Verification Test**

This chapter covers preparation and equipment required for doing the calibration and performance verification tests.

Purpose of Tests

The calibration and performance test procedures verify the electrical performance of the Agilent Technologies N8972A, N8973A, N8974A and N8975A series of Noise Figure Analyzers (NFAs) in accordance with their published specifications.

NOTE

You do not need to access the interior of the instrument to perform the tests.

If for any reason the unit measures out-of-specification, then adjustment procedures are supplied where applicable.

The Noise Figure Analyzers must be able to reach thermal equilibrium in accordance with the temperature stability specifications before performing any tests or adjustments.

NOTE

System performance is only guaranteed if each instrument in the test system/process is within the manufacturer's recommended calibration period.

Calibration Cycle

The analyzer requires periodic verification of operational performance. Under normal use and environmental conditions, the instrument should be calibrated at 12 month intervals.

The tables on the following pages list the tests required to perform the annual calibration, thus periodically verifying the instruments performance.

Before You Start

Switch on the Noise Figure Analyzer and let it warm up for 1 hour.

Read the rest of this section before you start any of the tests, and make a copy of the relevant test records for the model you are testing provided in Appendices A through D.

CAUTION

Ensure that the recommended torque settings detailed in Table 1-3 are adhered to at all times.

CAUTION

Ensure that a valid ENR measurement table has been loaded from the C: or A: drive before carrying out any performance test. The analyzer will not perform a measurement without an ENR table loaded.

Recording the Test Results

Performance verification test records for each Noise Figure Analyzer are provided in the section following the tests.

Each test result is identified as a TR (test record) entry in the performance tests and in Appendix pertaining to the model you are testing. We recommend that you make a copy of the performance verification test record, record the test results on the copy, and keep the copy for your calibration test record. This record could prove valuable in tracking gradual changes in test results over long periods of time.

Recommended Test Equipment

The following tables list the recommended test equipment for the performance tests. The tables also list recommended equipment for the Noise Figure Analyzer adjustment procedures.

When performing the performance test manually any recommended equipment that meets the critical specifications given in the table can be substituted for the recommended model when manually testing.

NOTE Substitution is not permitted when using the automated performance verification and adjustment software.

Table 1-1 Recommended Test Equipment

Equipment description	Critical specification for equipment substitution	Recommended model
Universal Counter	Time Interval Range: 25 ms to 100 ms Single Operation Range: +2.5 to -2.5 Vdc	53132A
Frequency Standard	Frequency: 10 MHz Timebase Accuracy: < 1 x 10 ⁻¹⁰ /day	5071A
Vector Network Analyzer 1	10 MHz to 3 GHz	3753ES or 8753ET, opt 004
Vector Network Analyzer 2	3 GHz to 26.5 GHz	8722ES or 8722ET, opt 004
Type N Calibration Kit	Impedance: 50 Ω UUT: N8972A and N8973A	85032B
3.5mm Calibration Kit	Impedance: 50 Ω Frequency Band: 10 MHz to 3 GHz UUT: N8974A and N8975A	85033D

Table 1-1 Recommended Test Equipment

Equipment description	Critical specification for equipment substitution	Recommended model
3.5mm Calibration Kit	Impedance: 50 Ω Frequency Band: 3 GHz to 26.5 GHz UUT: N8974A and N8975A	85052D
Synthesized Sweeper	Frequency Range: 10 MHz to 26.5 GHz Frequency Accuracy (CW): 0.02% Power Level Range: -55 dBm	83620/30/40/50B Option 001 or 008
Digital Multimeter	Input Resistance of 10 M Ω Accuracy of 10 mV on 100 V range	3458A
Attenuator/Switch Driver	Compatible with 8494G/H Programmable step attenuators	11713A
1 dB Step Attenuator	Attenuation Range: 0 to 11 dB Frequency Range: 50 MHz Connectors: 3.5 mm (F) Calibrated at 50 MHz with accuracy of 0.010 dB	8494G/H Option 2
Noise Source	Frequency Range: 10 MHz to 6.7 GHz Typical ENR: 4.5 - 6.5 dB Connection: 3.5 mm(M) or Type N	346A Std or Option 001
Noise Source	Frequency Range: 10 MHz to 26.5 GHz Typical ENR: 12.0 - 17.0 dB Connection: 3.5 mm(M)	346C

Preparing for Calibration and Performance Verification Test
Recommended Test Equipment

Table 1-2 Recommended Accessories, Adaptors and Cables

Equipment description	Critical specification for equipment substitution	Recommended model
BNC Lead (X 2)	Length 122 cm (48 in.), Frequency 10 MHz	10503A
Cable	50 Type N (M to M) Frequency Band: 3 GHz to 26.5 GHz	11500C
Cable (X 2)	10 MHz to 26.5 GHz 3.5mm (M) to 3.5 mm (M), 61 cm (24 in.)	11500E
Microwave Cable 2	2.4 mm (M) to 2.4 mm (M), 81 cm (32 in.) Frequency band: 3 GHz to 26.5 GHz	85133C
Adapter	50 Type N (F) to 7 mm (included in 85032B Type N Calibration Kit)	85054-60001
Adapter	50 Type N (F) to 3.5 mm Precision (F)	1250-1745
Adapter	2.4 mm (M) to 3.5 mm Precision (F)	11901C
Adapter	N8972A/N8973A Type N (M) to 3.5 mm (F) OR N8974A/N8975A 3.5 mm Precision (F) to 3.5 mm (F)	1250-1744 1250-1749 or 83059A
Adapter	83620/83630 3.5 mm Precision (F) to 3.5 mm (F) OR 83640/83650 2.4 mm Precision (F) to 3.5 mm (F)	1250-1749 or 83059A 11901C
DVM Adapter	BNC (F) to Dual Banana Plug (M) Adapter, 50 Ω	E9637A
BNC Lead	Length 12 cm (48 in.), Frequency 10 MHz	10503A

Table 1-3

Recommended Torque Settings

Type	Description
Precision 7mm	12 lb-in (136 N-cm.)
Precision 3.5mm	8 lb-in (90 N-cm)
SMA	5 lb-in (56 N-cm) Use the SMA wrench to connect male SMA connectors to female precision 3.5mm connectors. Connections of male precision 3.5mm. connectors to female SMA connectors can be made with the precision 3.5mm torque wrench (8 lb-in).
Type-N	Type-N connectors may be connected finger tight. If a torque wrench is used, 12 lb-in (136 N-cm) is recommended.

Performance Verification and Adjustment Procedures

To perform a calibration run, the performance verification tests listed in Table 1-4 below must be completed.

If any of the performance verification tests fail, perform the corresponding calibration adjustment listed in Table 1-4.

If the performance verification tests fail and no calibration adjustment procedure is available, the instrument must be returned to Agilent Technologies for repair. Please contact your local Agilent Technologies Customer Sales and Service Office for replacement parts or repair service information. See the *NFA User's Guide* for the address of your nearest office.

Table 1-4 Verification and adjustment listings

Test no.	Performance Verification Test	Calibration Adjustments
1	10 MHz Out Frequency Reference Accuracy	Test 2 (if applicable)
2	10 MHz Out Frequency Reference Adjustment	
3	Input VSWR	
4	Frequency Accuracy	
5	Noise Source Supply Accuracy	
6	Noise Figure Range and Accuracy	
7	Gain Measurement Uncertainty	
8	Instrument Noise Figure	
9	Measurement Jitter	

2**Test Descriptions**

This chapter describes each test required for calibration and performance verification.

10 MHz Out Frequency Reference Accuracy

Test Description

The test applies to NFAs with either the standard 10 MHz frequency reference or 10 MHz precision frequency reference (Option 1D5).

The test measures both the frequency reference accuracy and the ability to set the timebase. The frequency reference accuracy is measured with the NFA's 10 MHz REF OUT connected to the frequency counter's Channel A input. A cesium beam frequency standard, or some other 10 MHz \pm "house standard" provides the frequency reference for the frequency counter. The timebase to be set is measured by changing the setting of the digital-to-analog converter (DAC) which controls the frequency of the timebase. The frequency difference over the range of DAC settings is calculated and compared to the specification.

Test Specification

	Standard	Option 1D5
Ageing Rate	< ± 2 ppm/year	< ± 1 ppm/year
Settability	< ± 0.5 ppm	< ± 0.01 ppm
Temperature Stability	< ± 6 ppm	< ± 0.01 ppm

Related Adjustment

10 MHz Frequency Reference Adjustment (see page 18).

Required Test Equipment

Table 2-1 10 MHz Out Frequency Reference Accuracy Test Equipment

Equipment description	Critical specification for equipment substitution	Recommended model
Universal Counter	Time Interval Range: 25ms to 100ms Single Operation Range: +2.5 to -2.5Vdc	53132A
Frequency Standard	Frequency: 10 MHz Timebase Accuracy (Aging): $< 1 \times 10^{-10}/\text{day}$	5071A
BNC Lead (X 2)	Length 122cm (48 in.), Frequency 10 MHz	10503A

The frequency standard provides the reference for the Universal Counter. You can use a company-specific standard in place of the 5071A, providing it meets the critical specifications as listed in Table 2-1.

Test Setup

Before starting the 10 MHz Out Frequency Reference Accuracy Test, connect the equipment as shown in Figure 2-1.

Figure 2-1 10 MHz Out Frequency Reference Accuracy Test Setup

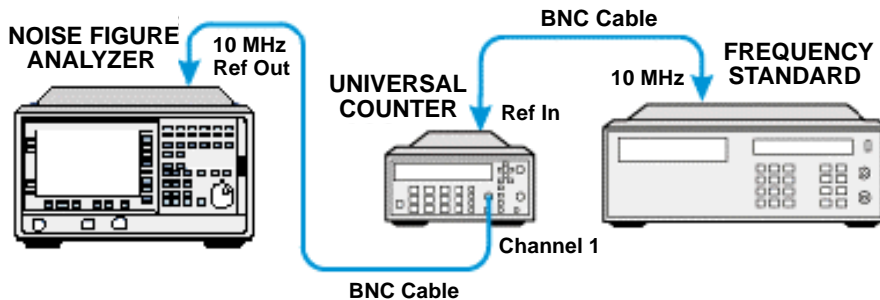

Test Procedure

NOTE

The NFA must be on and in internal frequency mode for at least 1 hour before you start the test.

NOTE

Throughout the 10 MHz Out Frequency Reference Accuracy Test Procedure the term 'the Worksheet' refers to the 10 MHz Out Frequency Reference Accuracy Test Worksheet on page 17 and the term 'the Test Record' refers to the 10 MHz Out Frequency Reference Accuracy Test Record detailed in the relevant Appendix for the model number being tested.

- Step 1.** Check that the NFA is not in the external reference mode. If `Ext Ref` appears on the screen, the NFA is in external reference mode: disconnect the external reference from the 10 MHz Ref Input.
- Step 2.** Ensure that the NFA's preset condition is set to its factory settings.
- Press the **System** key, the **More** menu item, then set the **Power On/Preset** menu item to Power On(Preset) and **Preset** to Preset (Factory).
- Step 3.** Preset the NFA by pressing the **Preset** key. Wait for the routine to finish.
- Step 4.** Set the Universal Counter controls as follows:
1. Press **Gate** and **ExtArm**
 2. Press any one of the arrow keys until Time is displayed.
 3. Press **Gate** and **ExtArm** again and using the arrow keys, set the Time to 10s and press **Enter** to set the value.
 4. On Channel 1, press **50Ω / 1MΩ** until the LED is lit.
 5. On Channel 1, press **x10 Attenuator** until the LED is extinguished.
 6. On Channel 1, press **AC/DC** until LED next to DC extinguished.
 7. On Channel 1, press **100 Hz Filter** until the LED is extinguished.

8. On Channel 1, press **Trigger/Sensitivity** until Auto Trig is displayed.
9. Use the arrow keys (←→) to toggle to Off.
10. Press **Freq** and **Ratio**.

Step 5. When the Universal Counter reading has stabilized, record the reading in the Worksheet as Counter Reading 1 with 0.1 Hz resolution.

This reading is taken as the actual frequency reference of the NFA. Ensure that the measured value is within the published specifications of ± 5 Hz for the standard, or ± 0.1 Hz for Option 1D5.

Step 6. Increase the NFA's fine DAC control by 1 step from its initial value.

Press the **System** key, then the **More, More** and **Service** menu keys. Enter the service password -2010, press **Enter**, then press **Service, Time Base,** and **Fine** menu items. Press the Up Arrow key to increment the **Fine** control menu item by 1. The value displayed in the **Fine** menu item is now 1 more than the initial value.

Step 7. When the frequency counter reading has stabilized, record reading in the Worksheet as Counter Reading 2 with 0.1 Hz resolution.

Step 8. Decrease the NFA's fine DAC control by 1 step to return to its initial value detailed in step 6, then again decrease the NFA's fine DAC control by 1 step.

Step 9. When the frequency counter reading has stabilized, record the reading in the Worksheet as Counter Reading 3 with 0.1 Hz resolution.

Step 10. Press **Preset** on the NFA to return the DAC settings to their initial values.

Step 11. Subtract Counter Reading 1 from Counter Reading 2 and record the difference in the Worksheet as the Positive Frequency Change.

Positive Frequency Change = Counter Reading 2 - Counter Reading 1

Step 12. Subtract Counter Reading 1 from Counter Reading 3 and record the difference in the Worksheet as the Negative Frequency Change.

Negative Frequency Change = Counter Reading 1 - Counter Reading 3

10 MHz Out Frequency Reference Accuracy

- Step 13.** Compare the Positive Frequency Change and Negative Frequency Change values recorded in the Worksheet and record the largest value in the Worksheet as the Maximum Frequency Change.
- Step 14.** Divide the Maximum Frequency Change by 2 (Maximum Frequency Change/2) and record the result as the settability in the Worksheet.
- Step 15.** Ensure that the calculated measurement figure given in the Worksheet is within the published specification of ± 5 Hz (± 0.1 Hz for Option 1D5).
- Step 16.** Once verified that the value is within specifications, Counter Reading 1 with 0.1 Hz resolution is then taken as the actual frequency reference of the Noise Frequency Analyzer and this reading is recorded on the Test Record.
- Step 17.** Once verified that the value is within specifications, the measured frequency is then recorded on the Test Record.

Table 2-2 10 MHz Out Frequency Reference Accuracy Test Worksheet

Description	Calculations	Measurement
Counter Reading 1	Reading	_____ Hz
Counter Reading 2	Reading	_____ Hz
Counter Reading 3	Reading	_____ Hz
Positive Frequency Change =	Counter Reading 2 - Counter Reading 1	_____ Hz
Negative Frequency Change =	Counter Reading 1 - Counter Reading 3	_____ Hz
Maximum Frequency Change =	Highest Positive or Negative Value	_____ Hz
Stability =	Maximum frequency Change / 2	_____ Hz

10 MHz Out Frequency Reference Adjustment

Test Description

The adjustment applies to NFAs with both the standard 10 MHz frequency reference and 10 MHz precision frequency reference (Option 1D5).

The adjustment is performed by calculating the actual frequency error in Hertz from Counter Reading 1 given in the 10 MHz Reference Accuracy Test (see page 12). The negative or positive error is used to define what the new DAC setting should be. After the DAC settings are adjusted and saved, the 10 MHz Reference Accuracy Test is re-run to verify the unit meets its published specification.

Required Test Equipment

Table 2-3 **10 MHz Out Frequency Reference Adjustment Test Equipment**

Equipment description	Critical specification for equipment substitution	Recommended model
Universal Counter	Time Interval Range: 25ms to 100ms Single Operation Range: +2.5 to -2.5Vdc	53132A
Frequency Standard	Frequency: 10 MHz Timebase Accuracy (Aging): $< 1 \times 10^{-10}/\text{day}$	5071A
BNC Lead (X 2)	Length 122cm (48 in.), Frequency 10 MHz	10503A

The frequency standard provides the reference for the Universal Counter. You can use a company-specific standard in place of the 5071A, provided it meets the critical specifications listed in Table 2-3.

Test Setup

Before starting the 10 MHz Out Frequency Reference Adjustment, connect the equipment as shown in Figure 2-2.

Figure 2-2 10 MHz Out Frequency Reference Adjustment Test Setup

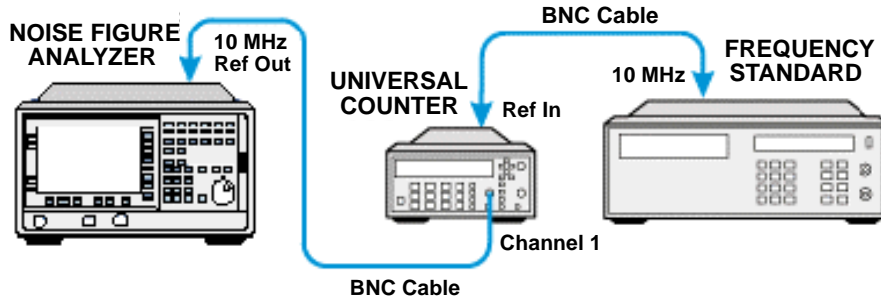

Test Procedure

NOTE

Before performing any adjustments ensure that the 10 MHz Frequency Reference Accuracy test has been done and that the measured frequency is outside the published specification.

NOTE

The NFA must be on and in internal frequency mode for at least 1 hour before you start the test.

10 MHz Out Frequency Reference Adjustment

Step 1. Note Counter Reading 1 for the 10 MHz Reference Accuracy Test and calculate the actual error in Hertz.

$$\text{Actual Error} = 10 \text{ MHz} - \text{Counter Reading 1}$$

Step 2. With the actual error calculated, determine which DAC setting to adjust from the table below.

Table 2-4 DAC setting adjustments

Control Setting	Standard Step Size (Hz)	Option 1D5 Step Size (Hz)
Coarse	≈ 7 Hz	≈ 0.1 Hz
Fine	≈ 1 Hz	≈ 0.0015 Hz

Example 2-1 Standard NFA Actual Error

If a standard NFA Actual Error = 10,000,000 Hz - 10,000,012 Hz

the error is -12 Hz

From Table 2-4, the DAC setting must be decremented by 1 coarse setting and 5 fine settings giving an approximate -12 Hz adjustment. Therefore, if the original settings were, for example, Coarse = 127 and Fine = 136, then the new settings after adjustment are Coarse = 126, Fine = 131.

NOTE

A negative error value decrements [↓], while a positive error value increments [↑].

Step 3. Access the **Service** menus **Time Base** sub-menu and press the **System** key. Then press the **More**, **More** and **Service** menu keys. Enter the service password -2010, press **Enter**, then press **Service** and **Time Base**.

Decrement [↓] the NFAs DAC settings by pressing **Coarse** once and **Fine** five times.

OR

You can type in the new value on the numeric keypad and then press **Enter**.

10 MHz Out Frequency Reference Adjustment

- Step 4.** Wait for the frequency counter reading to stabilize and ensure that the adjusted value is within the published specification. Repeat the adjustment procedure until the correct value is obtained.
- Step 5.** Press **Save** from the **Time Base** sub-menu to ensure that the values are stored in memory.

NOTE

It is recommended that you preset the NFA and repeat the 10 MHz Frequency Reference Accuracy Test (see page 12) to verify the adjusted DAC settings.

Input VSWR

Test Description

The Input VSWR test measures the worst case VSWR over each of the specified frequency bands detailed in the Table 2-1 on page 22. The test measures VSWR directly from the Network Analyzer, however the conversion below can be used if measuring return loss.

VSWR or voltage standing wave ratio can be calculated from the reflection coefficient using the following equation:

Equation 2-1

$$VSWR = \frac{[1 + rho]}{[1 - rho]} \cong \left(VSWR = \frac{[1 + \rho]}{[1 - \rho]} \right)$$

Table 2-5 VSWR Frequency Test Bands

	N8972A	N8973A	N8974A	N8975A
PART 1 CAL VNA 10 MHz - 1.5 OR 3.0 GHz	●	●	●	●
PART 2 TEST VSWR 10 MHz - 500 MHz	●	●	●	●
PART 3 TEST VSWR 500 MHz -1000 MHz	●	●	●	●
PART 4 TEST VSWR 1000 MHz -1500 MHz	●	●	●	●

Table 2-5 VSWR Frequency Test Bands

	N8972A	N8973A	N8974A	N8975A
PART 5 TEST VSWR 1500 MHz -3000 MHz		●	●	●
PART 6 CAL VNA 3.0 GHz - 6.7 OR 26.5 GHz			●	●
PART 7 TEST VSWR 3.0 GHz -6.7 GHz			●	●
PART 8 TEST VSWR 6.7 GHz -20.0 GHz				●
PART 9 TEST VSWR 20.0 GHz -26.5 GHz				●

NOTE ● denotes test required for associated model number.

NOTE The NFA uses several frequency dependent paths within the front end assemblies to cover its operating range. It is therefore not possible to complete a single VSWR swept measurement at a single fixed frequency point over its entire operating range, as the NFA automatically switches at approximately 500 MHz and 3000 MHz, dependant on the fixed frequency setting.

VSWR Test Specification

	N8972A	N8973A	N8974A	N8975A
10 MHz to 500 MHz	< 1.6:1	< 1.6:1	< 1.6:1	< 1.6:1
500 MHz to 1000 MHz	< 1.8:1	< 1.8:1	< 1.8:1	< 1.8:1
1000 MHz to 1500 MHz	< 1.9:1	< 1.9:1	< 1.9:1	< 1.9:1
1500 MHz to 3000 MHz	N/A	< 1.8:1	< 1.8:1	< 1.8:1
3000 MHz to 6700 MHz	N/A	N/A	< 1.3:1	< 1.3:1
6700 MHz to 20000 MHz	N/A	N/A	N/A	< 2.1:1
20000 MHz to 26500 MHz	N/A	N/A	N/A	< 2.4:1

Related Adjustments

None

Required Test Equipment

Table 2-6 Test Equipment required for Input VSWR test

Equipment description	Critical specification for equipment substitution	Recommended model
Vector Network Analyzer 1	10 MHz to 3 GHz	8753ES or 8753ET, Option 004 ^a
Vector Network Analyzer 2	3 GHz to 26.5 GHz	8722ES or 8722ET, Option 004 ^b
N Type Calibration Kit	Impedance: 50 Ω Frequency Band: 10 MHz to 3 GHz ^c UUT: N8972A and N8973A	85032B

Table 2-6 Test Equipment required for Input VSWR test

Equipment description	Critical specification for equipment substitution	Recommended model
3.5mm Calibration Kit	Impedance: 50 Ω Frequency Band: 10 MHz to 3 GHz UUT: N8974A and N8975A	85033D
3.5mm Calibration Kit	Impedance: 50 Ω Frequency Band: 3 GHz to 26.5 GHz UUT: N8974A and N8975A	85052D
Cable	50 N Type (M to M) Frequency Band: 3 GHz to 26.5 GHz	11500C
Adapter	50 N Type (F) to 7 mm (included in 85032B N Type Calibration Kit)	85054-60001
Adapter	2.4 mm (M) to 3.5 mm Precision (F)	1250-1745
Adaptor	2.4 mm (M) to 3.5 mm Precision (F)	11901C
UWave Cable	2.4 mm (M) to 2.4 mm (M), 81 cm (32 in.) Frequency band: 3 GHz to 26.5 GHz	85133C

- a. Option 004 is only required for the ET models.
- b. Option 004 is only required for the ET models.
- c. Part 1 of this procedure lists hard and soft keys for the 8753ET. Other network analyzers such as the 8753D or E may have different hard and soft key labelling. Please refer to the appropriate Users Guide for the relevant menu maps.

Test Setup

Figure 2-3 **Input VSWR: Equipment Connection**

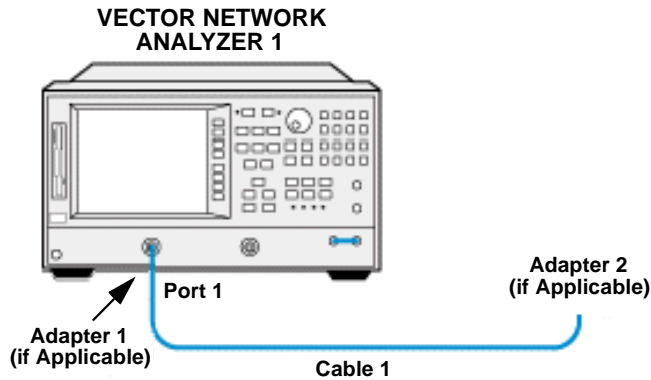

Test Procedure

NOTE

Throughout the Input VSWR Test Procedure the term 'the Test Record' refers to the Input VSWR Test Record detailed in the relevant Appendix for the model number being tested.

The Input VSWR test requires the following stages:

1. Calibrating the Vector Network Analyzer 1 from 10 MHz to 1.5 GHz or 3 GHz
2. Measuring VSWR from 10 MHz to 500 MHz
3. Measuring VSWR from 500 MHz to 1000 MHz
4. Measuring VSWR from 1000 MHz to 1500 MHz
5. Measuring VSWR from 1500 MHz to 3000 MHz
6. Calibrating the Vector Network Analyzer 2 from 3 GHz to 6.7 GHz or 26.5 GHz
7. Measuring VSWR from 3000 MHz to 6700 MHz

8. Measuring VSWR from 6700 MHz to 26500 MHz

Calibrating the Vector Network Analyzer 1 from 10 MHz to 1.5 GHz or 3 GHz

- Step 1.** Press the **Preset** key on the Network Analyzer.
- Step 2.** Set the Active Channel to 1 (press **Chan 1**).
- Step 3.** Set the measurement mode to S11 (press the **Meas** key and **Reflection**).
- Step 4.** Set the start and stop frequencies.
- The start and stop frequencies depend on the frequency range of the NFA:
- For the N8972A model (frequency range 10 MHz to 1.5 GHz): press **Start**, **1, 0, M/μ** then **Stop**, **1, ., 5, G/n**
- For the N8973/4/5A models (frequency range 10 MHz to 3.0 GHz): press **Start**, **1, 0, M/μ** then **Stop**, **3, ., 0, G/n**
- Step 5.** Set the measurement format to SWR (press the **Format** key and **SWR**).
- Step 6.** Set the number of measurement points to 401 points (press the **Sweep Setup** key, and **NUMBER of POINTS**, **4, 0, 1, x1**)
- Step 7.** Set the power level to -30dBm (press the **Sweep Setup** key and **Power**, **-, 3, 0, x1**)
- Step 8.** Connect the test equipment as shown in Figure 2-3.

NOTE

During this test procedure, ET model network analyzers do not require adaptor 1, while NFA N8972A and N8973A do not require adaptor 2.

Figure 2-4 **Input VSWR Test Setup 1**

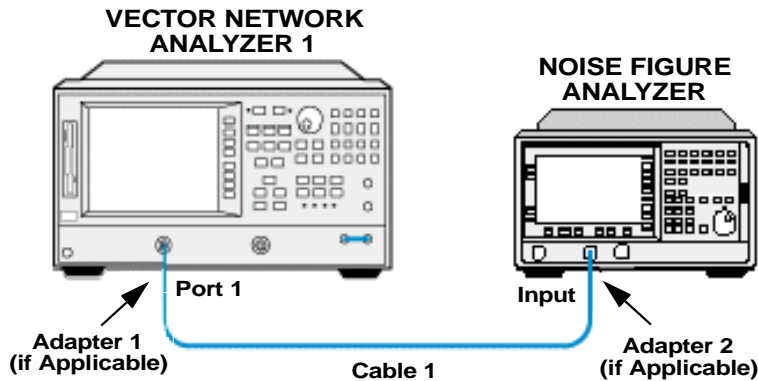

Step 9. Select the relevant calibration kit in use from the Cal menu, as the calibration kit selection is dependant on the NFA being tested (press the **Cal** key, **Calibration Kit** selection and **Return**).

NOTE

The connector type applies to the test port or adaptor if fitted and not the NFA under test.

- Step 10.** Select an S11 port calibration (press the **Cal** key, then **Calibrate Menu** and **Reflection 1-port**).
- Step 11.** Connect the Open to the test port or, if fitted, the adapter and perform the open calibration (press **Opens** and then select the relevant menu key).
- Step 12.** Connect the Short to the test port or, if fitted, the adapter and perform the open calibration (press **Shorts** and then select the relevant menu key).
- Step 13.** Connect the Load to the test port or, if fitted, the adapter and perform the open calibration (press **Load**, select the relevant menu key and then **done 1-port CAL**).
- Step 14.** Save the calibration (press the **Save/recall** key and then **Save State**).

Measuring VSWR from 10 MHz to 500 MHz

- Step 1.** Connect the test equipment as shown in Figure 2-4 on page 28.
- Step 2.** Set the Network Analyzer Start/Stop frequencies from 10 MHz to 500 MHz.

Press the Start key then **1, 0, M/μ**; then press the Stop key and **5, 0, 0 M/μ**.
- Step 3.** On the NFA ensure that the preset is set to the factory settings (press the **System** key and **More, Power On/Preset, Power On (Preset)** and **Preset (Factory)**).
- Step 4.** On the NFA press the **Preset** key and wait for the routine to finish
- Step 5.** Set sweep to single (press the **Sweep** key and **Sweep Mode: Single**).
- Step 6.** Set the frequency mode to fixed (press the **Frequency/Points** key and **Freq Mode, Fixed**).
- Step 7.** Set the fixed frequency to 250 MHz (press the **Frequency/Points** key and **Fixed Freq, 2, 5, 0, MHz**).
- Step 8.** Restart the measurement sweep on the DUT (press the **Restart** key).
- Step 9.** Set the Network Analyzer to autorange (press the **Scale Ref** key and **Auto Scale**).
- Step 10.** Using the marker peak function on the network analyzer, determine the maximum displayed VSWR over the measured frequency range (press the **Marker Fctn** key and **Mkr Search [ON], Search: Max**).
- Step 11.** Record the maximum displayed signal frequency and VSWR on the Test Record.
- Step 12.** Verify that the measured VSWR from 10 MHz to 500 MHz is within the published specification.

Test Descriptions
Input VSWR

Measuring VSWR from 500 MHz to 1000 MHz

- Step 1.** Connect the test equipment as shown in Figure 2-4 on page 28.
- Step 2.** Set the Network Analyzer Start/Stop frequencies from 500 MHz to 1000 MHz.
Press the **Start** key and then **0**, **.**, **5**, **G/n**; then press the **Stop** key and **1**, **.**, **0**, **G/n**
- Step 3.** Set the fixed frequency of the NFA to 750 MHz (press the **Frequency/Points** key and **Fixed Freq**, **7**, **5**, **0**, **MHz**).
- Step 4.** Restart the measurement sweep on the DUT (press the **Restart** key).
- Step 5.** Using the marker peak function on the network analyzer, determine the maximum displayed VSWR over the measured frequency range (press the **Marker Fctn** key, **Mkr Search [ON]** and then **Search: Max**).
- Step 6.** Record the maximum displayed signal frequency and VSWR on the Test Record.
- Step 7.** Verify that the measured VSWR from 500 MHz to 1000 MHz is within the published specification.

Measuring VSWR from 1000 MHz to 1500 MHz

- Step 1.** Connect the test equipment as shown in Figure 2-4 on page 28.
- Step 2.** Set the Network Analyzer Start/Stop frequencies from 1000 MHz to 1500 MHz.

Press the **Start** key and then 1, ., 0, **G/n**; then press the **Stop** key and 1, ., 5, **G/n**
- Step 3.** Set the fixed frequency of the NFA to 1250 MHz (press the **Frequency/Points** key and then **Fixed Freq, 1, 2, 5, 0, MHz**).
- Step 4.** Restart the measurement sweep on the DUT (press the **Restart** key).
- Step 5.** Using the marker peak function on the network analyzer, determine the maximum displayed VSWR over the measured frequency range (press the **Marker Fctn** key, **Mkr Search [ON]** then **Search: Max**).
- Step 6.** Record the maximum displayed signal frequency and VSWR on the Test Record.
- Step 7.** Verify that the measured VSWR from 1000 MHz to 1500 MHz is within the published specification.

Test Descriptions
Input VSWR

Measuring VSWR from 1500 MHz to 3000 MHz

- Step 1.** Connect the test equipment as shown in Figure 2-4 on page 28.
- Step 2.** Set the Network Analyzer Start/Stop frequencies from 1.5 GHz to 3.0 GHz.
- Press the **Start** key then **1**, **.**, **5**, **G/n** then the **Stop** key and **3**, **.**, **0**, **G/n**
- Step 3.** Set the fixed frequency of the NFA to 1750 MHz (press the **Frequency/Points** key and then **Fixed Freq**, **1**, **7**, **5**, **0**, **MHz**).
- Step 4.** Restart the measurement sweep on the DUT (press the **Restart** key).
- Step 5.** Using the marker peak function on the network analyzer, determine the maximum displayed VSWR over the measured frequency range (press the **Marker Fctn** key and **Mkr Search [ON]**, **Search: Max**).
- Step 6.** Record the maximum displayed signal frequency and VSWR on the Test Record.
- Step 7.** Verify that the measured VSWR from 1500 MHz to 3000 MHz is within the published specification.

Calibrating the Vector Network Analyzer 2 from 3 GHz to 6.7 GHz or 26.5 GHz

Step 1. Press the **Preset** key on the Vector Network Analyzer.

Step 2. Set the Active Channel to 1 (press **Chan 1**).

Step 3. Set the measurement mode to S11 (press the **Meas** key and **Reflection**).

Step 4. Set the start and stop frequencies.

The start and stop frequencies depend on the frequency range of the NFA:

For the N8974A (frequency range 3 GHz to 6.7 GHz): press **Start, 3, G/n** then **Stop, 6, ., 7, G/n**

For the N8975A (frequency range 3 GHz to 26.5 GHz): press **Start, 3, G/n** then **Stop, 2, 6, ., 5, G/n**

Step 5. Set the measurement format to SWR (press the **Format** key and **SWR**).

Step 6. Set the number of measurement points to 401 points (press the **Sweep Setup** key, and **NUMBER of POINTS, 4, 0, 1, x1**

Step 7. Set the power level to -30dBm (press the **Sweep Setup** key and **Power, -, 3, 0, x1**

Step 8. Connect the type adapter and the μ Wave cable to port 1 as shown in figure inFigure 2-5.

Figure 2-5 **Vector Network Analyzer: Adaptor Connection**

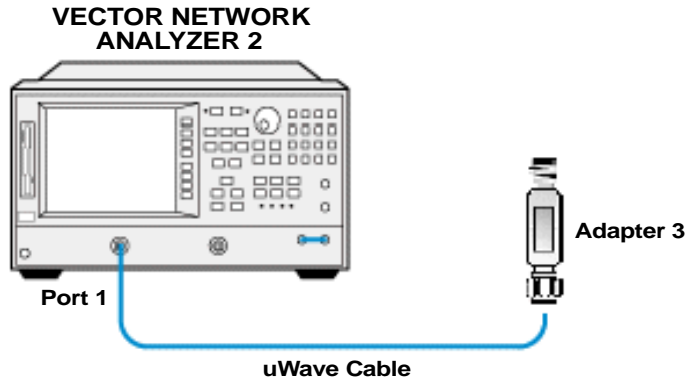

Step 9. As the calibration kit selection is dependant on the NFA being tested, select the relevant calibration kit in use from the Cal menu (press the **Cal** key, **Calibration Kit** selection and **Return**).

NOTE

The connector type applies to the test port or adaptor if fitted and not the NFA under test.

Step 10. Select an S11 port calibration (press the **Cal** key, then **Calibrate Menu** and **Reflection 1-port**).

Step 11. Connect the Open to the test port or, if fitted, the adapter and perform the open calibration (press **Opens** and then select the relevant menu key).

Step 12. Connect the Short to the test port or, if fitted, the adapter and perform the open calibration (press **Shorts** and then select the relevant menu key).

Step 13. Connect the Load to the test port or, if fitted, the adapter and perform the open calibration (press **Load**, select the relevant menu key and then **done 1-port CAL**).

Step 14. Save the calibration (press the **Save/recall** key and then **Save State**).

Measuring Input VSWR from 3000 MHz to 6700 MHz

Figure 2-6 **Input VSWR Test Setup 2**

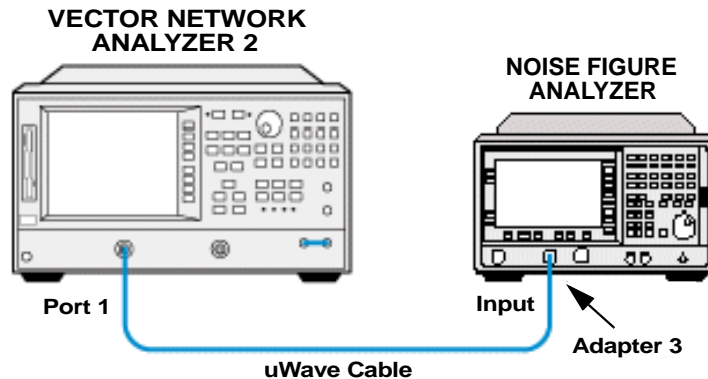

- Step 1.** Connect the test equipment as shown in Figure 2-6 on page 35.
- Step 2.** Set the Network Analyzer Start/Stop to measure the DUT's input VSWR from 3000 MHz to 6700 MHz.

Press the **Start** key and then **3,., 0, G/n**; then press the **Stop** key and **6, ., 7, G/n**
- Step 3.** Set the fixed frequency of the NFA to 5000 MHz (press the **Frequency/Points** key and then **Fixed Freq, 5, GHz**).
- Step 4.** Restart the measurement sweep on the DUT (press the **Restart** key).
- Step 5.** Using the marker peak function on the network analyzer, determine the maximum displayed VSWR over the measured frequency range (press the **Marker Fctn** key, **Mkr Search [ON]** then **Search: Max**).
- Step 6.** Record the maximum displayed signal frequency and VSWR on the Test Record.
- Step 7.** Verify that the measured VSWR from 3000 MHz to 6700 MHz is within the published specification.

Test Descriptions
Input VSWR

Measuring Input VSWR from 6700 MHz to 20000 MHz

- Step 1.** Connect the test equipment as shown in Figure 2-6 on page 35.
- Step 2.** Set the Network Analyzer Start/Stop to measure the DUT's input VSWR from 6700 MHz to 20000 MHz.

Press the **Start** key and then **6**, **.**, **7**, **G/n**; then press the **Stop** key and **2**, **0**, **.**, **0**, **G/n**
- Step 3.** Set the fixed frequency of the NFA to 15 GHz (press the **Frequency/Points** key and then **Fixed Freq**, **1**, **5**, **GHz**).
- Step 4.** Restart the measurement sweep on the DUT (press the **Restart** key).
- Step 5.** Using the marker peak function on the network analyzer, determine the maximum displayed VSWR over the measured frequency range (press the **Marker Fctn** key, **Mkr Search [ON]** then **Search: Max**).
- Step 6.** Record the maximum displayed signal frequency and VSWR on the Test Record.
- Step 7.** Verify that the measured VSWR from 6700 MHz to 20000 MHz is within the published specification.

Measuring Input VSWR from 20000 MHz to 26500 MHz

- Step 1.** Connect the test equipment as shown in Figure 2-6 on page 35.
- Step 2.** Set the Network Analyzer Start/Stop to measure the DUT's input VSWR from 20000 MHz to 26500 MHz.

Press the **Start** key and then **2, ., 0, G/n**; then press the **Stop** key and **2, 6, ., 5, G/n**
- Step 3.** Set the fixed frequency of the NFA to 23 GHz (press the **Frequency/Points** key and then **Fixed Freq, 2, 3, GHz**).
- Step 4.** Restart the measurement sweep on the DUT (press the **Restart** key).
- Step 5.** Using the marker peak function on the network analyzer, determine the maximum displayed VSWR over the measured frequency range (press the **Marker Fctn** key, **Mkr Search [ON]** then **Search: Max**).
- Step 6.** Record the maximum displayed signal frequency and VSWR on the Test Record.
- Step 7.** Verify that the measured VSWR from 20000 MHz to 26500 MHz is within the published specification.

Frequency Accuracy

Test Description

The NFA filter shape is asymmetrical. The center frequency is defined at the half power level under the curve. The frequency accuracy tests are performed by measuring selected P_{hot} points along the filter curvature. The half power value of the P_{hot} measurements is then calculated. The frequency which closest matches this value is given as the center frequency point.

For test purposes the narrow bandwidths are verified at the narrowest bandwidth of 100 kHz. This is due to the fact that the NFA uses digital sample processing (DSP). It is therefore only necessary to verify the narrowest bandwidth with the most accurate specification. Model N8972A does not support narrow bandwidth functionality.

Test Specification

	B a n d w i d t h					
Frequency range 10 MHz to 3 GHz	4 MHz ±100 KHz + χ	2 MHz ±20 KHz + χ	1 MHz ±20 KHz + χ	400 KHz ±20 KHz + χ	200 KHz ±20 KHz + χ	100 KHz ±20 KHz + χ
Frequency range 3 GHz to 26.5 GHz	4 MHz ±400 KHz + χ	2 MHz ±400 KHz + χ	1 MHz ±200 KHz + χ	400 KHz ±80 KHz + χ	200 KHz ±40 KHz + χ	100 KHz ±20 KHz + χ
χ is equal to the tuned frequency * (1 ± frequency standard in use).						

NOTE

On the N8972A model only a DSP bandwidth of 4 MHz is available.

Related Adjustment

None

Required Test Equipment

Table 2-7 **Equipment required for Frequency Accuracy test**

Equipment description	Critical specification for equipment substitution	Recommended model
Synthesized Sweeper (see note)	Frequency Range: 10 MHz to 26.5 GHz Frequency Accuracy (CW): 0.02% Power Level Range: -55dBm	83620/30/40/50B Option 001 and 008
Adapter 1	N8972/3A N Type (M) to 3.5mm (F) N8974/5A 3.5mm Precision (F) to 3.5mm (F)	1250-1744 1250-1749 or 83059B
Adapter 2	83620/30 3.5mm Precision (F) to 3.5mm (F) 83640/50 2.4mm Precision (F) to 3.5mm (F)	1250-1749 or 83059B 11901B
RF Cable	10 MHz to 26.5 GHz 3.5mm (M) to 3.5mm (M), 61 cm (24 in.)	11500E
Frequency Standard	Frequency: 10 MHz Timebase Accuracy (Aging): $< 1 \times 10^{-10}/\text{day}$	5071A
BNC Lead (X 2)	Length 122cm (48 in.), Frequency 10 MHz	10503A

NOTE

Synthesized Sweeper model 83620B cannot be used test NFA N8975A.

Test Setup

Figure 2-7 Frequency Accuracy test setup

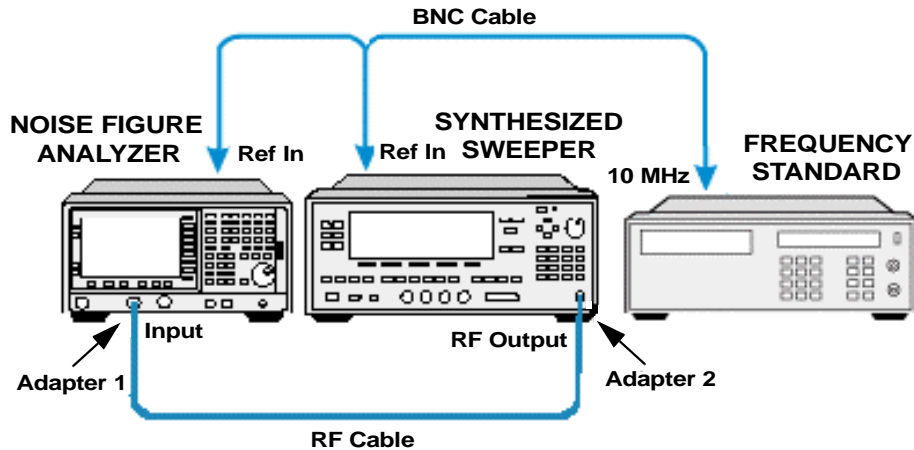

Test Procedure

NOTE

Throughout the Frequency Accuracy Test Procedure the term 'the Worksheet' refers to the Frequency Accuracy Test Worksheet on page 45 and the term 'the Test Record' refers to the Frequency Accuracy Test Procedure Test Record detailed in the relevant Appendix for the model number being tested.

Step 1. Connect the equipment as shown in Figure 2-7 on page 40.

Step 2. Set the Synthesized Sweeper as follows:

1. Press the **Preset** key and wait for the preset routine to complete.
2. Set the power level to -70dBm (press the **Power Level** key and -, 7, 0, dB(m)).
3. Switch **RF ON**

Step 3. Set the NFA as follows:

1. On the NFA ensure that the preset is set to the factory settings (press the **System** key and **More, Power On/Preset, Power On (Preset)** and **Preset (Factory)**).
2. Press the **Preset** key and wait for the preset routine to complete.
3. Set the measured results to P_{hot} (press the **Result** key and **Phot**).
4. Select a single graphical display of P_{hot} , press the  key.
5. Set sweep to single (press the **Sweep** key and **Sweep Mode: single**).
6. Set the frequency mode to sweep (press the **Frequency/Points** key and **Freq Mode, Sweep**).
7. Set the number of measured points to 201 (press the **Frequency/Points** key and **More, Points, 2, 0, 1, Enter**).
8. Set the measured units to linear (press the **Scale** key and **Units Linear**).
9. Fix the IF Gain (press the **System** key, **More, More**, and **Service**. Enter the service password **-, 2, 0, 1, 0** press **Enter, Service** and then press **IF Test** and **Fixed IF Gain (On)**. Set the **IF Gain Value** to 16 and press **IF Gain Value, 1, 6, Enter**).
10. For models N8974A and N8975A, run the YIG Tuned Filter alignment (press the **System** key, **Alignment**, and then press **Align YTF** and wait for the alignment routine to complete).

Step 4. Set the Sweeper frequency to 14 MHz, the first frequency listed in the Test Record (press the **CW** key and **1, 4, MHz**).

Step 5. Set the NFA frequency to 14 MHz, the first frequency as listed in the Test Record (press the **Frequency/Points** key and **Center Freq, 1, 4, MHz**).

Step 6. Set the NFA frequency span to 8 MHz, the first frequency span as listed in the Test Record (press the **Frequency/Points** key and **Freq Span, 8, MHz**).

Step 7. Set the NFA bandwidth to 4 MHz, the first bandwidth as listed in the Test Record (press the **Averaging/Bandwidth** key and **Bandwidth, 4 MHz**).

Step 8. Restart the NFA measurement sweep (press the **Restart** key).

Test Descriptions
Frequency Accuracy

- Step 9.** Once the single sweep is complete set the NFA to autorange (press the **Scale** key and **Autoscale**).
- Step 10.** Before obtaining the P_{hot} measurements and performing the calculations ensure that the filter shape is similar to the one relating to the bandwidth in Figure 2-8 and Figure 2-9.
- Step 11.** Obtain the P_{hot} tabulated measurements (press the **Format** key and **Table**). Use the tab keys below the display to scroll through the results.

Alternatively output the trace data to disk, using the File Manager as follows:

1. Insert a writable disk in drive A: and press the **File** key and **Save, Trace**.

Ensure that drive A: is selected as the **To: path**.

2. Enter the file name or use the default provided and press **Enter** to save the *.CSV file to disk.

The data can now be used in a spreadsheet application to perform the following calculations.

Figure 2-8 Typical 4 MHz bandwidth filter shape

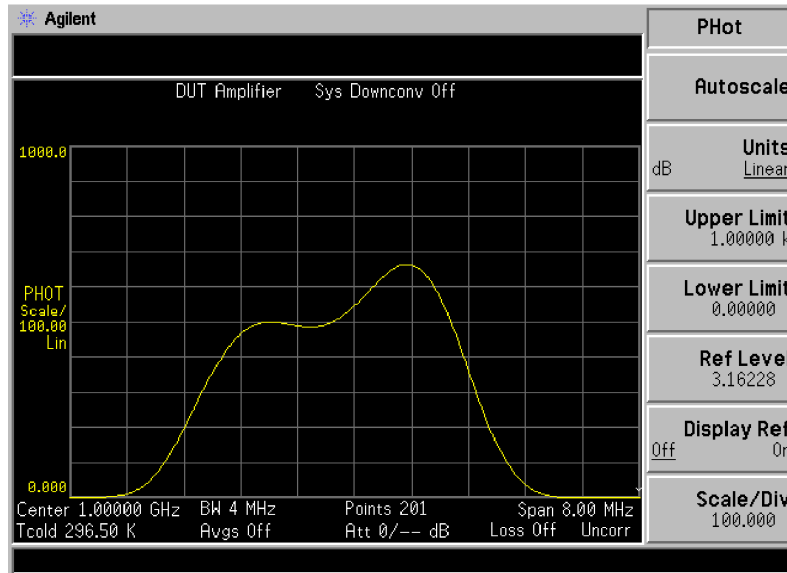
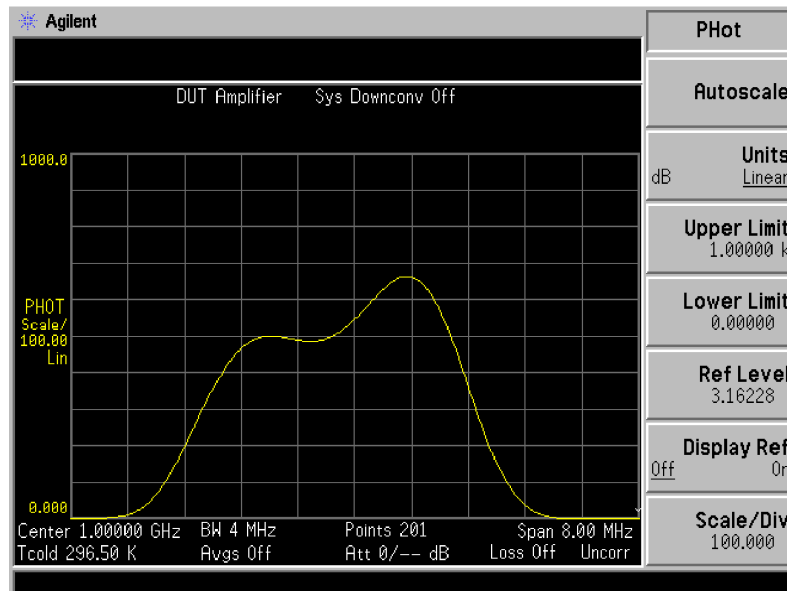

Figure 2-9 Typical 100 KHz bandwidth filter shape



Test Descriptions
Frequency Accuracy

- Step 12.** Perform the frequency accuracy calculations either using a spreadsheet such as Microsoft® Excel (see page 49), or manually (see page 50).
- Step 13.** Repeat steps 4 to 12 above for the remaining frequencies, spans and bandwidths as listed in the data into the Test Record. Ensure the measured values are within its published specification.
- Step 14.** Reset the IF Gain (press the **System** key, then **More, More,** and **Service**. Enter the service password -, 2, 0, 1 ,0 press **Enter, Service** and then press **IF Test** and **Fixed IF Gain (Off)**).

NOTE

The DSP bandwidths are verified at the narrowest bandwidth only. This is due the fact that they use digital sample processing (DSP), therefore it is only necessary to verify the narrowest bandwidth. The NFA N8972A does not support DSP.

Table 2-8 Frequency Accuracy Test Worksheet

No.	Frequency (MHz)	Summed Phot reading (dB) Equation 1	No.	Frequency (MHz)	Summed Phot reading (dB) Equation 1	No.	Frequency (MHz)	Summed Phot reading (dB) Equation 1
1			22			43		
2			23			44		
3			24			45		
4			25			46		
5			26			47		
6			27			48		
7			28			49		
8			29			50		
9			30			51		
10			31			52		
11			32			53		
12			33			54		
13			34			55		
14			35			56		
15			36			57		
16			37			58		
17			38			59		
18			39			60		
19			40			61		
20			41			62		
21			42			63		

Test Descriptions
Frequency Accuracy

Table 2-8 Frequency Accuracy Test Worksheet

No.	Frequency (MHz)	Summed Phot reading (dB) Equation 1	No.	Frequency (MHz)	Summed Phot reading (dB) Equation 1	No.	Frequency (MHz)	Summed Phot reading (dB) Equation 1
64			85			106		
65			86			107		
66			87			108		
67			88			109		
68			89			110		
69			90			111		
70			91			112		
71			92			113		
72			93			114		
73			94			115		
74			95			116		
75			96			117		
76			97			118		
77			98			119		
78			99			120		
79			100			121		
80			101			122		
81			102			123		
82			103			124		
83			104			125		
84			105			126		

Table 2-8 Frequency Accuracy Test Worksheet

No.	Frequency (MHz)	Summed Phot reading (dB) Equation 1	No.	Frequency (MHz)	Summed Phot reading (dB) Equation 1	No.	Frequency (MHz)	Summed Phot reading (dB) Equation 1
127			148			169		
128			149			170		
129			150			171		
130			151			172		
131			152			173		
132			153			174		
133			154			175		
134			155			176		
135			156			177		
136			157			178		
137			158			179		
138			159			180		
139			160			181		
140			161			182		
141			162			183		
142			163			184		
143			164			185		
144			165			186		
145			166			187		
146			167			188		
147			168			189		

Test Descriptions
Frequency Accuracy

Table 2-8 Frequency Accuracy Test Worksheet

No.	Frequency (MHz)	Summed Phot reading (dB) Equation 1	No.	Frequency (MHz)	Summed Phot reading (dB) Equation 1	No.	Frequency (MHz)	Summed Phot reading (dB) Equation 1
190			194			198		
191			195			199		
192			196			200		
193			197			201		

Center Frequency: _____ MHz

Bandwidth: _____ MHz

Span: _____ MHz

Equation: $\frac{1}{2}$ Power = Summed Phot reading 201/2

$\frac{1}{2}$ Power = _____ WattHz

Performing the frequency accuracy calculations using the CSV file in a spreadsheet

The following procedure uses Microsoft Excel.

- Step 1.** Open Excel.
- Step 2.** Open the .csv file from the A: drive. From the **File** menu select **Open** and **Look in: (A:)**. Select files of **Type: Text Files (*.prn; *.txt; *.csv)**.

Figure 2-10 Example Excel File

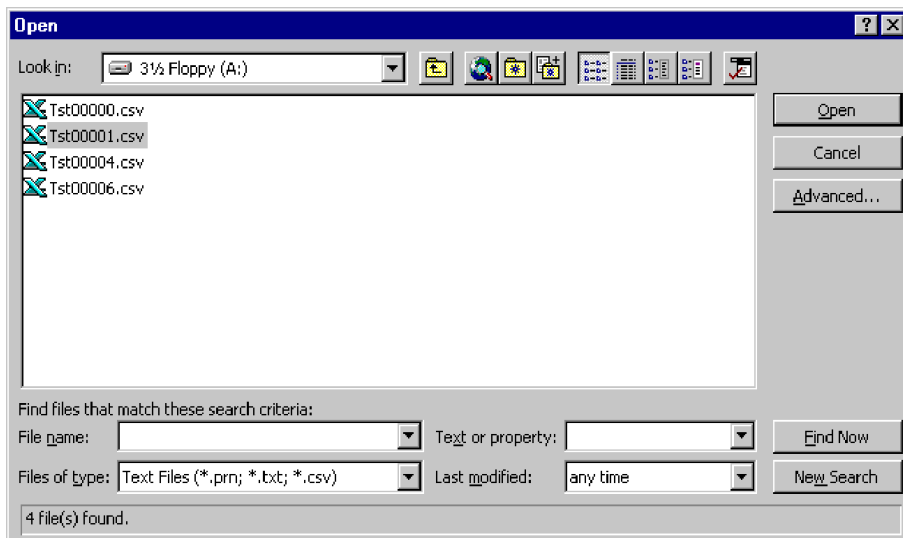

Column A contains the measured frequency. Column B contains the corresponding Linear P_{hot} value. Disregard Column C null terminator information.

- Step 3.** Increase the column widths to 20 to view the data more accurately.
- Step 4.** Enter the following formula into cell D1 = SUM(B\$1:B1), copy this formula and paste it from cell D2:D201.
- Step 5.** Enter the following formula into cell D202 =D201/2. This value returns the $\frac{1}{2}$ Power reading.

Test Descriptions
Frequency Accuracy

Step 6. Use Cells D1 to D201 as a look up reference and find the cell, which closest matches the ½ Power Reading in cell D202.

The corresponding frequency in Column A is given as the center frequency point. Enter the reading into the appropriate column in the Test Record. Ensure that the measured value meets its published specification.

Performing the frequency accuracy calculations manually

Step 1. Using the displayed P_{hot} results sum the values and enter the summed values on the Test Worksheet Table on page 45.

Example 2-2 1 GHz CW at the 4 MHz bandwidth

For the 1 GHz CW at the 4 MHz bandwidth each P_{hot} reading shown in the Figure 2-12 on page 51 is summed with the previous cell(s) until the total power under the curve is equated in the lower right hand column. Example sum reading 1 to reading 6 = 0.369.

Figure 2-11 Displayed Table Values



Figure 2-12 **Example 2-2 summed P_{hot} for reading 1 to reading 6**

No	Frequency (MHz)	Phot Reading (dB)	No	Frequency (MHz)	Summed Phot Reading (dB) Equation
1	996.0000	0.060	1	996.0000	0.060
2	996.0400	0.061	2	996.0400	0.121
3	996.0800	0.061	3	996.0800	0.182
4	996.1200	0.061	4	996.1200	0.243
5	996.1600	0.062	5	996.1600	0.305
6	996.2000	0.064	6	996.2000	0.369
7	996.2400	0.066	7	996.2400	0.435
8	996.2800	0.068	8	996.2800	0.503
9	996.3200	0.072	9	996.3200	0.575
10	996.3600	0.077	10	996.3600	0.652
11	996.4000	0.085	11	996.4000	0.737
12	996.4400	0.097	12	996.4400	0.834
13	996.4800	0.115	13	996.4800	0.949
14	996.5200	0.141	14	996.5200	1.090
15	996.5600	0.176	15	996.5600	1.266

Step 2. Calculate the half power level from the data as shown in Figure 2-12.

$$\text{Equation: } \frac{1}{2} \text{ Power} = \text{Summed } P_{hot} \text{ Reading } 201 / 2$$

Step 3. Use the summed value column as shown in Figure 2-12 as a look up reference and find the cell, which closest matches the $\frac{1}{2}$ Power Reading. The corresponding frequency column is given as the center frequency point. Enter the reading into the Test Worksheet Table on page 45 and ensure the measured value is within its published specification.

Noise Source Supply Accuracy

Test Description

The Noise Source Supply Accuracy test verifies that the noise source drive supply meets the published specifications. A Digital Multimeter is connected to the +28V noise source supply BNC connection. The supply is then tested in the on and off states.

Test Specification

- Noise Off $0.0V \pm 1.0V$
- Noise On $+28V \pm 0.1V$

Related Adjustment

None

Required Test Equipment

The following equipment is required for the Noise Source Supply Accuracy test.

Table 2-9 Equipment required for Noise Source Supply Accuracy test

Equipment description	Critical specification for equipment substitution	Recommended model
Digital Multimeter	Input Resistance of 10 M Ω Accuracy of 10 mV on 100 V range	3458A
DVM BNC Adapter	BNC (F) to Dual Banana Plug (M) Adapter, 50 Ω	E9637A
BNC Lead	Length 122 cm (48 in.), Frequency 10 MHz	10503A

Test Setup

Figure 2-13 Equipment setup for Noise Source Supply Accuracy test

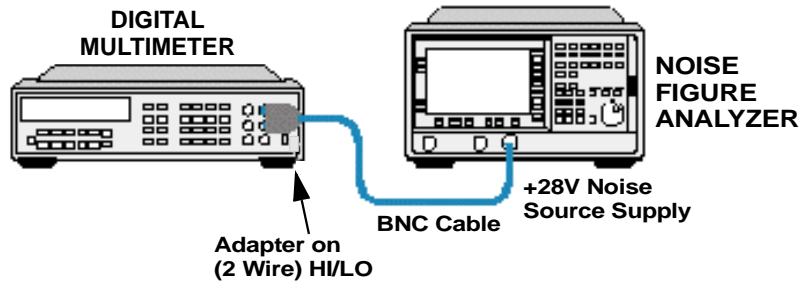

Test Procedure

NOTE

Throughout the Noise Source Supply Accuracy Test Procedure the term 'the Test Record' refers to the Noise Source Supply Accuracy Test Record detailed in the relevant Appendix for the model number being tested.

- Step 1.** Connect the equipment as shown in Figure 2-13.
- Step 2.** Select the DC range on the digital multimeter (press **DCV** in the **FUNCTION/RANGE** menu).
- Step 3.** Ensure that the preset is set to factory settings (press the **System** key, then **More**, **Power On (Preset)** and **Preset (Factory)**).
- Step 4.** On the NFA press the **Preset** key and wait for the routine to finish.
- Step 5.** Set sweep to single (press **Sweep**, **Sweep Mode: single**).
- Step 6.** Set the noise source off (press the **System** key, then **More**, **More** and **Service**. Press **Enter Password** then enter the service password -2010. Press **Enter** then **Service** and **Noise Source Off**).
- Step 7.** Enter the digital multimeter reading into the Test Record as the Noise Source Supply Off measurement.

Noise Source Supply Accuracy

- Step 8.** Set the noise source on (press the **System** key, then **More, More** and **Service**. Press **Noise Source On**). Press **Enter Password** then enter the service password -2010. Press **Enter** then **Service** and **Noise Source On**).
- Step 9.** Enter the digital multimeter reading in the Test Record as the Noise Source Supply On measurement.
- Step 10.** Press the **Preset** key to return to the default Noise Source Supply State.
- Step 11.** Verify that the measured values are within the published specifications.

Noise Figure Range and Accuracy

Test Description

A precision step attenuator, calibrated at 50 MHz with an accuracy of 0.010dB, is used as an external standard to measure the NFA's Noise Figure Range and Accuracy over a 22dB range. The results are then used to determine the Instrument Uncertainty for the given ENR values over their respective measurement ranges.

A 50 MHz CW signal is passed through a precision step attenuator. The signal path is referenced at 0dB attenuation. The attenuator is then stepped in 1dB steps from 1 to 11 taking the analyzers P_{hot} measurement at each step. Only one step attenuator is used in the measurement to reduce the overall measurement uncertainty of the standard. It is therefore necessary to re-reference the measurement and repeat the test covering the range from 12-22dB. All levels tested below 1dB are interpolated from the measured points, as the minimum step attenuator setting is 1dB.

For test purposes the Noise Figure Range and Accuracy is only tested at the lower frequency band with the most accurate specifications.

Test Specification

Table 2-10 **N8972A specification**

Noise Source ENR	4 - 7dB	12 - 17dB	20 - 22dB
Noise Figure Measurement Range	0 to 20dB	0 to 30dB	0 to 35dB
Instrument Uncertainty	± 0.10dB	± 0.10dB	± 0.15dB

Table 2-11 **N8973A, N8974A and N8975A specification**

Noise Source ENR	4 - 7dB	12 - 17dB	20 - 22dB
Noise Figure Measurement Range	0 to 20dB	0 to 30dB	0 to 35dB
Instrument Uncertainty	± 0.05dB	± 0.05dB	± 0.10dB

Test Descriptions
Noise Figure Range and Accuracy

Related Adjustment

None

Required Test Equipment

Table 2-12 Noise Figure Range and Accuracy test equipment

Equipment description	Critical specification for equipment substitution	Recommended model
Synthesized Sweeper	Frequency Range: 50 MHz Frequency Accuracy (CW): 0.02% Power Level Range: -54dBm to -65dBm	83620/30/40/50B Option 001 and 008
Attenuator/Switch Driver	Compatible with 8494G/H Programmable step attenuators	11713A
1 dB Step Attenuator	Attenuation Range: 0 to 11dB Frequency Range: 50 MHz Connectors: 3.5mm (F) Calibrated at 50 MHz with accuracy of 0.010 dB	8494G/H Option 002
Adapter 1	N8972/3A N Type (M) to 3.5mm (F) N8974/5A 3.5mm Precision (F) to 3.5mm (F)	1250-1744 1250-1749 or 83059B
Adapter	83620/30 3.5mm Precision (F) to 3.5mm (F) 83640/50 2.4mm Precision (F) to 3.5mm (F)	1250-1749 or 83059B 11901B
RF Cable (X 2)	50 MHz 3.5mm (M) to 3.5mm (M), 61cm (24 in.)	11500E

Test Setup

Figure 2-14 Equipment required for Noise Figure Range and Accuracy test

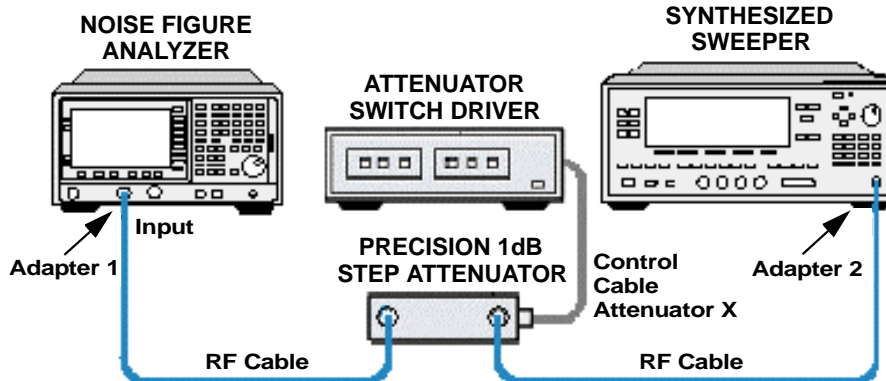

Test Procedure

NOTE

Throughout the Noise Figure Range and Accuracy Test Procedure the term 'the Worksheet' refers to the Noise Figure Range and Accuracy Test Worksheet on page 61 and the term 'the Test Record' refers to the Noise Figure Range and Accuracy Test Record detailed in the relevant Appendix for the model number being tested.

Step 1. Connect the equipment as shown in Figure 2-14.

Step 2. Set the Synthesized Sweeper as follows:

1. Press the **Preset** key.
2. Set the frequency to 50 MHz (press the **CW** key and **5, 0, MHz**).
3. Set the power level to -54 dBm (press the **Power Level** key and **-, 5, 4, dB(m)**).
4. Switch **RF ON**

Test Descriptions
Noise Figure Range and Accuracy

Step 3. Set the Switch Driver as follows:

1. Ensure the **LOCAL LED** is on.
2. Set the attenuator to 0dB. The settings are as follows:

Table 2-13

Switch Driver Attenuator Settings (1 = LED On, 0 = LED Off)

1dB Step Attenuator	Attenuator X			
	1	2	3	4
0	0	0	0	0
1	1	0	0	0
2	0	1	0	0
3	1	1	0	0
4	0	0	1	0
5	1	0	1	0
6	0	1	1	0
7	1	1	1	0
8	0	0	1	1
9	1	0	1	1
10	0	1	1	1
11	1	1	1	1

Step 4. Set the NFA as follows:

1. Ensure that the preset is set to factory settings (press the **System** key, then **More, Power On (Preset), Power On Preset and Preset (Factory)**).
2. Press the **Preset** key and wait for the routine to finish.
3. Set the measured result to Phot (press the **Result** key and **Phot**).
4. Set sweep to single (press the **Sweep** key and **Sweep Mode (Single)**).
5. Set the frequency mode to fixed (press the **Frequency/Points** key and **Freq Mode, Fixed**).

6. Set the frequency to 50 MHz (press the **Frequency/Points** key and **Fixed Freq, 5, 0, MHz**).
7. Set the averaging to 101 (press the **Averaging/Bandwidth** key and **Average Mode (Point), Averages, 1, 0, 1, Enter, Averaging On**).
8. Select the display to meter mode (press the **Format** key and **Format, Meter**).
9. Fix the IF Gain (press the **System** key then **More, More** and **Service**. Press **Enter Password**, then **-2010** and **Enter**. Then press **Service , IF Test** and **Fix IF Gain On**. Set the **IF Gain Value** to 16 and press **IF Gain Value, 1, 6** and **Enter**.

Step 5. Restart the NFA measurement sweep by pressing the **Restart** key.

Step 6. Record the measured P_{hot} value in the Worksheet as the -54dB Ref 1 Level.

Step 7. Step the attenuator in 1dB steps from 1 - 11dB recording the measured P_{hot} at each point in the Worksheet as the -55 to -65dB levels. Remember to press the **Restart** key at each measurement.

Step 8. Set the synthesizer power level to -65dBm (press the **Power Level** key, then **-, 6, 5, dB(m)**).

Step 9. Reset the attenuator to 0dB and press the **Restart** key to restart the NFA sweep.

Step 10. Record the measured P_{hot} value in the Worksheet as the -65dB Ref 2 Level.

Step 11. Step the attenuator in 1dB steps from 1 - 11dB recording the measured P_{hot} at each point in the Worksheet as the -66 to -76dB levels. Remember to press the **Restart** key at each measurement.

Step 12. Reset the IF Gain (press the **System** key then **More, More** and **Service**. Press **Enter Password**, then **-2010** and **Enter**. Then press **Service , IF Test** and **Fix IF Gain Off**).

Step 13. Enter the attenuator metrology data information in the Worksheet provided as Actual Attenuation using equation 1.

Step 14. Calculate the Measured Attenuation and enter the values in the Worksheet using equation 2.

Noise Figure Range and Accuracy

- Step 15.** Use the Actual and Measured attenuations given in the Worksheet to calculate the Actual and Measured Noise Figures in the Test Record.
- Step 16.** Calculate the Noise Figure Instrument Uncertainty Error for each ENR measurement range detailed in the relevant model number tables in Appendices A through D. Enter the values into the appropriate test record and ensure that the measured values are within their published specifications (pass/fail).

Table 2-14 Noise Figure Range and Accuracy Test Worksheet

Attenuator Step Size (dB)	Input Level (dBm)	Measured Phot (dB)	Range (dB)	Actual Attenuation (dB) Equation 1	Measured Attenuation (dB) Equation 2
0	-54 Ref 1	Ref 1	Ref 1	Ref 1	Ref 1
-----	-----	-----	0.125		
-----	-----	-----	0.5		
1	-55		1		
2	-56		2		
3	-57		3		
4	-58		4		
5	-59		5		
6	-60		6		
7	-61		7		
8	-62		8		
9	-63		9		
10	-64		10		
11	-65		11		
0 Ref 2	-65 Ref 2	Ref 2	Ref 2	Ref 2	Ref 2
1	-66		12		
2	-67		13		
3	-68		14		
4	-69		15		
5	-70		16		
6	-71		17		
7	-72		18		

Test Descriptions
Noise Figure Range and Accuracy

Table 2-14 Noise Figure Range and Accuracy Test Worksheet

Attenuator Step Size (dB)	Input Level (dBm)	Measured Phot (dB)	Range (dB)	Actual Attenuation (dB) Equation 1	Measured Attenuation (dB) Equation 2
8	-73		19		
9	-74		20		
10	-75		21		
11	-76		22		

Equation 1

Range_{dB} 0.125 = Metrology Data_{dB} at 1dB / 8

Range_{dB} 0.5 = Metrology Data_{dB} at 1dB / 2

Range_{dB} 1 to 11 = Metrology Data_{dB} from 1 to 11

Range_{dB} 12 to 22 = Metrology Data_{dB} from 1 to 11 + (11dB to re-reference)

Equation 2

Range_{dB} 0.125 = Measured Attenuation_{dB} at 1dB / 8

Range_{dB} 0.5 = Measured Attenuation_{dB} at 1dB / 2

Range_{dB} 1 to 11 = Measured Phot_{dB} Ref 1 - Measured Phot_{dB} from -55 to -65

Range_{dB} 12 to 22 = Measured Phot_{dB} Ref 2 - Measured Phot_{dB} from -66 to -76 + (11dB to re-reference)

NOTE The ENR values given in the calculations are taken to be 5dB, 15dB and 22dB respectively. The actual and measured attenuations supplied within the appropriate Test Records are calculated from in the equations in the Tables on page 63.

Table 2-15 4.5-6.5 dB Noise Source ENR Test Record

Actual NF range	= 5 dB ENR - 10LOG (10 [^] (Actual Attenuation _{dB} /10) -1)
Measured NF range	= 5 dB ENR - 10LOG (10 [^] (Measured Attenuation _{dB} /10) -1)
Instrumentation Uncertainty:	= Actual NF - Measured NF

Table 2-16 14-16 dB Noise Source ENR Test Record

Actual NF range	= 15 dB ENR - 10LOG (10 [^] (Actual Attenuation _{dB} /10) -1)
Measured NF range	= 15 dB ENR - 10LOG (10 [^] (Measured Attenuation _{dB} /10) -1)
Instrumentation Uncertainty:	
Range _{dB} 0.125 to 11	= Actual NF - Measured NF
Range _{dB} 12 to 15	= Actual NF - Measured NF + Instrumentation Uncertainty at 11 dB (re-reference)

Table 2-17 20-22 dB Noise Source ENR Test Record

Actual NF range	= 22 dB ENR - 10LOG (10 [^] (Actual Attenuation _{dB} /10) -1)
Measured NF range	= 22 dB ENR - 10LOG (10 [^] (Measured Attenuation _{dB} /10) -1)
Instrumentation Uncertainty:	
Range _{dB} 0.125 to 11	= Actual NF - Measured NF
Range _{dB} 12 to 22	= Actual NF - Measured NF + Instrumentation Uncertainty at 11 dB (re-reference)

Gain Measurement Uncertainty

NOTE

You must perform the Noise Figure Range and Accuracy performance test (see page 55) before this test.

Test Description

The NFA uses internal IF attenuator values for measuring gain. The test comprises of an internal IF attenuator calibration. Using an external 50 MHz CW signal at -46dBm the attenuator values are computed as error ratios.

The analyzer only uses a range of 40dB for any given measurement from -20dB to >+40dB within the available 0 - 70dB IF attenuator range. Therefore, the actual Instrumentation Uncertainty is calculated as the maximum peak to peak error over any 40dB range within the available 0 - 70dB IF attenuator range. The 30 available ranges are all tested for the maximum and minimum Peak to Peak values within their respective 40dB range. The 30 peak to peak values are then compared and the worst case error is reported as the Instrumentation Uncertainty error.

The graph below shows a typical plot of the data. 1 of the 30 available ranges is shown giving the typical Instrumentation Uncertainty for the specific range between 30 to 70dB.

Figure 2-15 Typical Instrumentation Uncertainty for the range 30 to 70dB

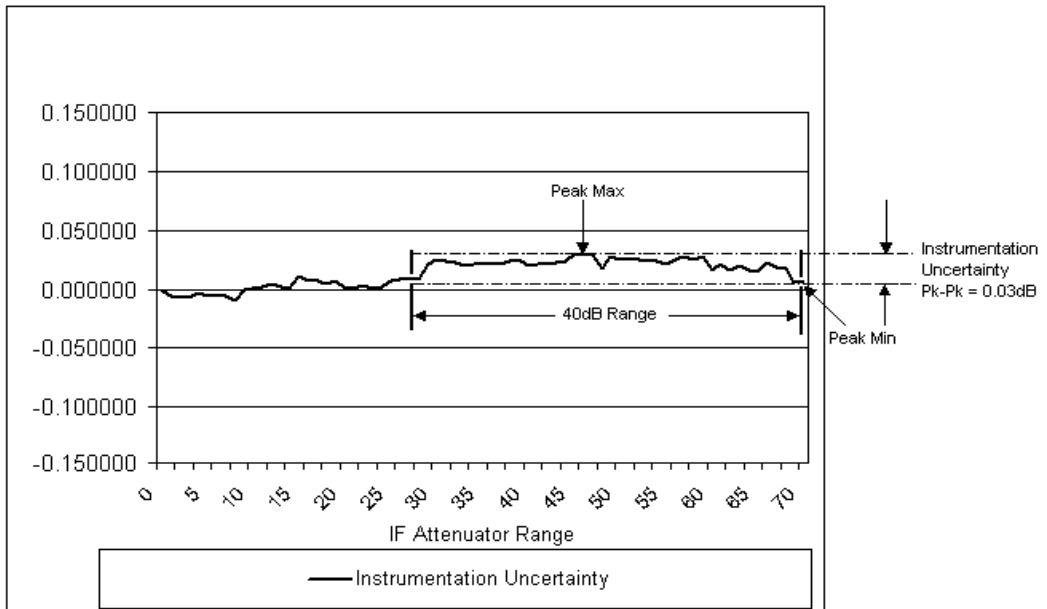

Test Specification

Gain Measurement Uncertainty Range: -20 to >+40dB

Instrumentation Uncertainty: $\pm < 0.17\text{dB}$

Related Adjustment

None

Test Descriptions
Gain Measurement Uncertainty

Required Test Equipment

Table 2-18 Equipment required for Gain Measurement Uncertainty test

Equipment description	Critical specification for equipment substitution	Recommended model
Synthesized Sweeper	Frequency Range: 50 MHz Frequency Accuracy (CW): 0.02% Power Level Range: -46 dBm	83620/30/40/50B Option 001 and 008
Adapter 1	N8972/3A N Type (M) to 3.5mm (F) N8974/5A 3.5mm Precision (F) to 3.5mm (F)	1250-1744 1250-1749 or 83059B
Adapter 2	83620/30 3.5mm Precision (F) to 3.5mm (F) 83640/50 2.4mm Precision (F) to 3.5mm (F)	1250-1749 or 83059B 11901B
RF Cable	50 MHz 3.5mm (M) to 3.5mm (M), 61cm (24 in.)	11500E

Test Setup

Figure 2-16 Gain Measurement Uncertainty Test Setup

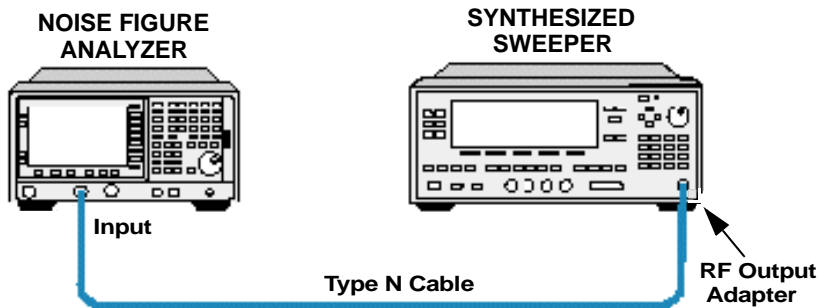

Test Procedure

NOTE

Throughout the Gain Measurement Uncertainty Test Procedure the term 'the Worksheet' refers to the Gain Measurement Uncertainty Test Worksheet 1 on page 69 or Worksheet 2 on page 71, and the term 'the Test Record' refers to the Gain Measurement Uncertainty Test Record detailed in the relevant Appendix for the model number being tested.

- Step 1.** Connect the equipment as shown in Figure 2-16.
- Step 2.** Set the Synthesized Sweeper as follows:
1. Press the **Preset** key.
 2. Set the frequency to 50 MHz (press the **CW** key, then **5, 0, MHz**).
 3. Set the power level to -46 dBm (press **Power Level**, then **-, 4, 6,dB(m)**).
 4. Switch **RF ON**.
 5. Set the frequency mode to fixed (press **Frequency/Points** key, **Frequency Mode** and **Fixed**).
 6. Set the frequency to 50 MHz (press **Frequency/Points** key, **Fixed Frequency**, then **5, 0, MHz**).
- Step 3.** Ensure that the preset is set to factory settings (press the **System** key, then **More, Power On/Preset, Power On (Preset) and Preset (Factory)**).
- Step 4.** Press the **Preset** key on the NFA and wait until the routine is finished.
- Step 5.** Run the IF attenuator calibration routine (press the **System** key, then **More, More** and **Service**. Press **Enter password**, then **-, 2, 0, 1, 0** and **Enter**. Then press **Service**, followed by **IF Test** and **Gain Lin Test**). The test takes approximately 30 seconds to complete the routine.
- Step 6.** Record the results. Press the **Gain Lin Results** menu item once the above routine is complete. Use the tab keys below the display to scroll through the results. Press [**←**] or [**→**]). Record the Delta results along side the corresponding index value in the Worksheet No. 1.

Gain Measurement Uncertainty

Step 7. Convert the delta ratios to dB error values using $10 \cdot \text{LOG}_{10}$ (Delta reading from index 1 to 71). Enter the value in the Worksheet No. 1.

Example: Index 16 = 1.004545 = $10 \cdot \text{LOG}_{10}(1.004545) = 0.019694\text{dB}$

Step 8. Using the error data calculated in the Worksheet No. 1, enter the peak-to-peak error in dB over the 30 available measurement ranges in the Worksheet 2.

Step 9. Record the worst Instrumentation Uncertainty into the Test Record and ensure that the measured value is within its published specification.

Table 2-19 Gain Measurement Uncertainty Worksheet 1

Index	Delta Ratio	Error (dB)	Index	Delta Ratio	Error (dB)
1			36		
2			37		
3			38		
4			39		
5			40		
6			41		
7			42		
8			43		
9			44		
10			45		
11			46		
12			47		
13			48		
14			49		
15			50		
16			51		
17			52		
18			53		
19			54		
20			55		
21			56		
22			57		
23			58		

Test Descriptions
Gain Measurement Uncertainty

Table 2-19 **Gain Measurement Uncertainty Worksheet 1**

Index	Delta Ratio	Error (dB)	Index	Delta Ratio	Error (dB)
24			59		
25			60		
26			61		
27			62		
28			63		
29			64		
30			65		
31			66		
32			67		
33			68		
34			69		
35			70		
			71		

Table 2-20

Gain Measurement Uncertainty Worksheet 2

Index Range	Measured Range (dB)	Peak-Peak Instrumentation Uncertainty (dB)
1 - 41	0 - 40	
2 - 42	1 - 41	
3 - 43	2 - 42	
4 - 44	3 - 43	
5 - 45	4 - 44	
6 - 46	5 - 45	
7 - 47	6 - 46	
8 - 48	7 - 47	
9 - 49	8 - 48	
10 - 50	9 - 49	
11 - 51	10 - 50	
12 - 52	11 - 51	
13 - 53	12 - 52	
14 - 54	13 - 53	
15 - 55	14 - 54	
16 - 56	15 - 55	
17 - 57	16 - 56	
18 - 58	17 - 57	
19 - 59	18 - 58	
20 - 60	19 - 59	
21 - 61	20 - 60	
22 - 62	21 - 61	

Test Descriptions
Gain Measurement Uncertainty

Table 2-20

Gain Measurement Uncertainty Worksheet 2

Index Range	Measured Range (dB)	Peak-Peak Instrumentation Uncertainty (dB)
23 - 63	22 - 62	
24 - 64	23 - 63	
25 - 65	24 - 64	
26 - 66	25 - 65	
27 - 67	26 - 66	
28 - 68	27 - 67	
29 - 69	28 - 68	
30 - 70	29 - 69	
31 - 71	30 - 70	

Instrument Noise Figure

Test Description

A noise source is connected to the NFA's input. The instrument then measures its own uncorrected noise figure. For test purposes the NFA is tested at the most accurate 20-26°C performance specification.

Test Specification

N8972A

10 MHz to < 500 MHz	< 4.4dB	+0.0025dB/MHz
500 MHz to 1500 MHz	< 5.9dB	+0.00135dB/MHz

N8973A

10 MHz to < 500 MHz	< 4.4dB	+0.0025dB/MHz
500 MHz to < 2300 MHz	< 5.9dB	+0.00135dB/MHz
2300 to 3000 MHz	< 2.9dB	+0.0015dB/MHz

N8974A and N8975A

10 MHz to < 500 MHz	< 4.4dB	+0.0025dB/MHz
500 MHz to < 2300 MHz	< 5.9dB	+0.00135dB/MHz
2300 MHz to 3000 MHz	< 2.9dB	+0.0015dB/MHz
>3000 MHz to 13200 MHz	<10.5dB	
>13200 MHz to 26500 MHz	<12.5dB	

NOTE

Specifications covering the frequency range of 10MHz to <3000 MHz are referenced to 0 MHz. To calculate the specification for any given frequency point within this range simply multiply the frequency by the corresponding dB/MHz value and add the initial dB value.

For example:

Frequency = 1500 MHz

Specification = $1500 * 0.00135 + 5.9\text{dB} = <7.925 \text{ dB}$

Figure 2-17 Typical plots with limit lines for the N8972A

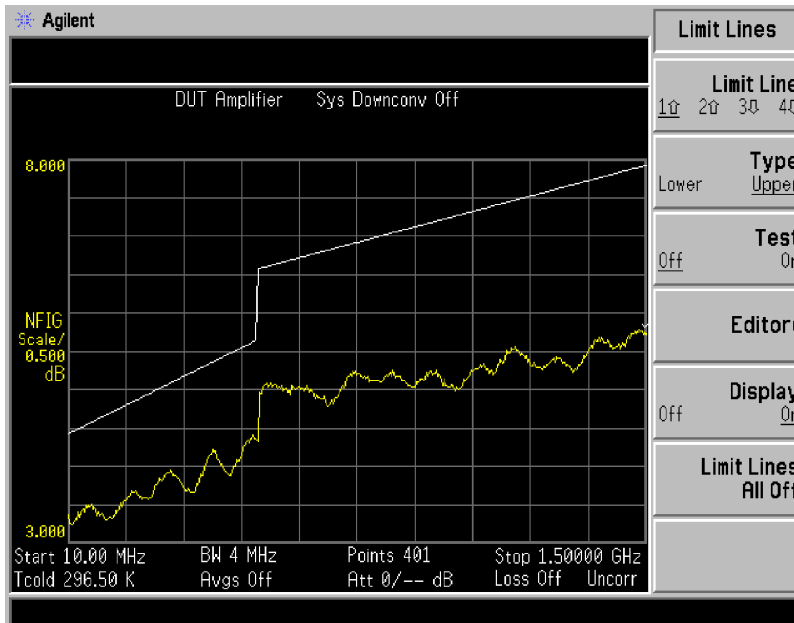

Figure 2-18 Typical plots with limit lines for the N8973A

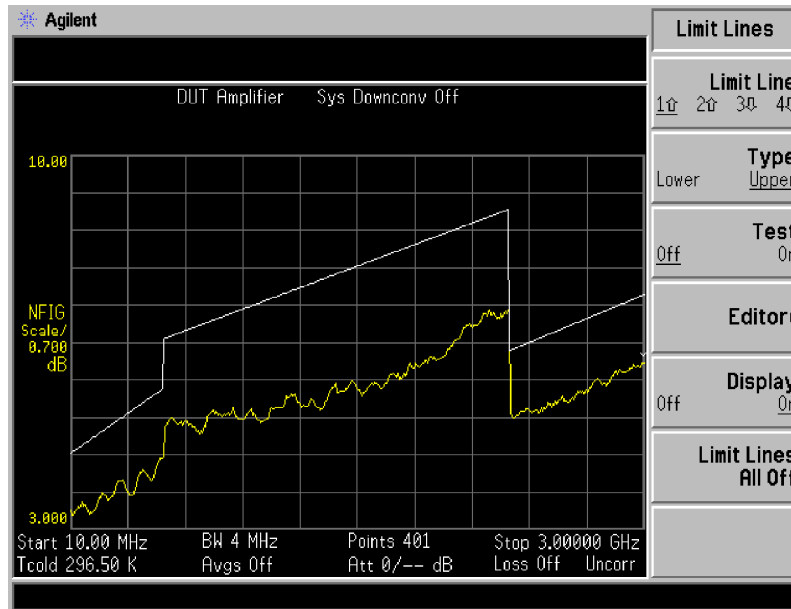

Figure 2-19 Typical plots with limit lines for the N8974A

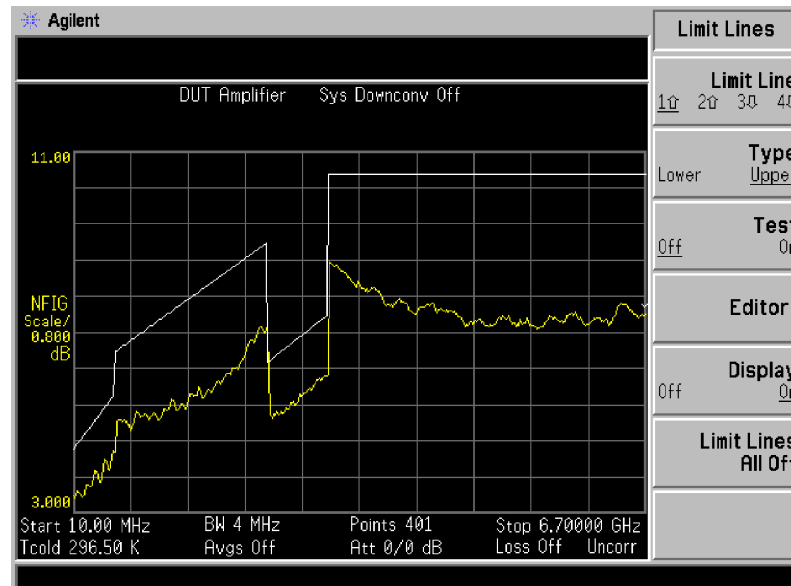
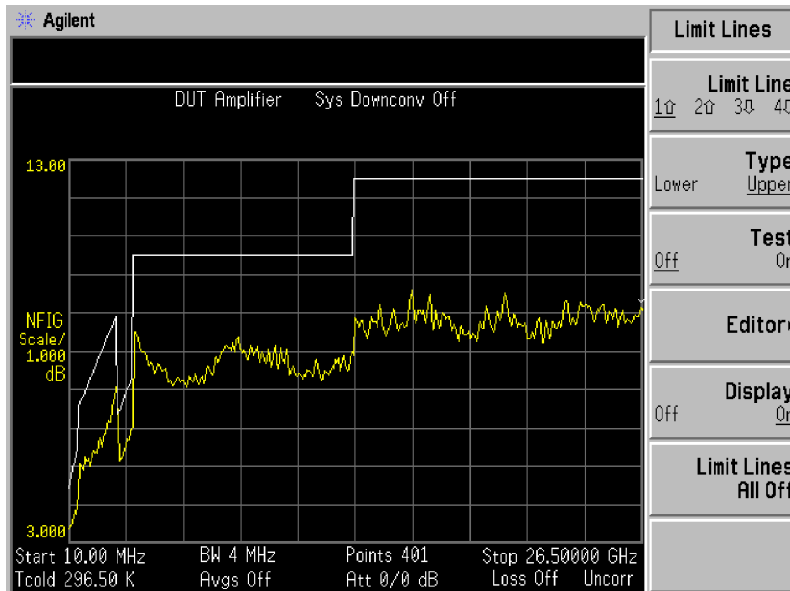

Figure 2-20 Typical plots with limit lines for the N8975A



Related Adjustment

None

Required Test Equipment

Table 2-21 Required equipment for Instrument Noise Figure Test

Equipment description	Critical specification for equipment substitution	Recommended model
Noise source	Frequency Range: 10 MHz to 3 GHz Typical ENR: 4.5 - 6.5 dB Connection: 3.5 mm (M) or N Type	346A standard or Option 001
Noise source	Frequency Range: 10 MHz to 26.5 GHz Typical ENR: 12.0 - 17.0 dB Connection: 3.5 mm (M) or N Type	346C

Table 2-21 Required equipment for Instrument Noise Figure Test

Equipment description	Critical specification for equipment substitution	Recommended model
Adapter	3.5 mm Precision (F) to 3.5 mm (F)	83059B
BNC Lead	Length 122 cm (48 in.), Frequency 10 MHz	10503A

NOTE Equipment selection for this test is dependant on the model number of the NFA. Reference must be made to Figure 2-21 for the actual equipment configuration required for each individual model number.

Test Setup

Figure 2-21 Instrument Noise Figure Test Setup

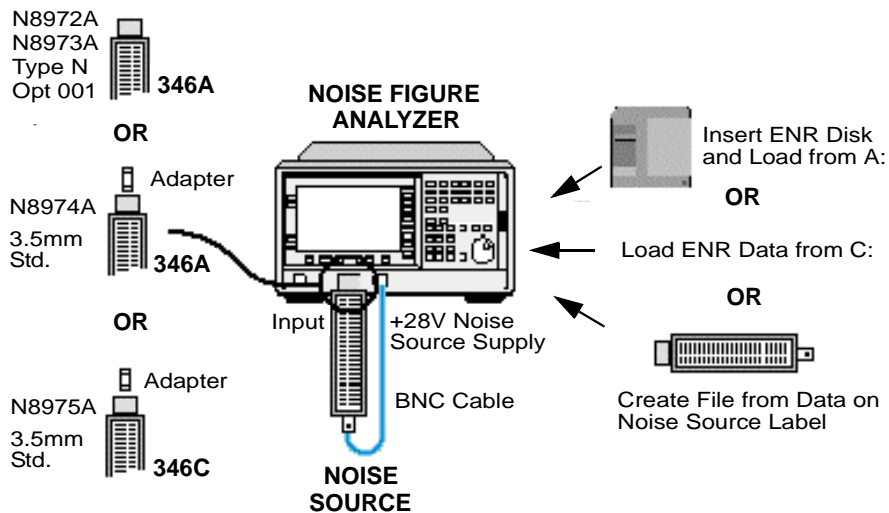

Test Procedure

NOTE

Throughout the Instrument Noise Figure Test Procedure the term 'the Test Record' refers to the Instrument Noise Figure Test Record detailed in the relevant Appendix for the model number being tested

- Step 1.** Connect the test equipment as shown in Figure 2-21 on page 77.
- Step 2.** Ensure that the preset is set to factory settings (press the **System** key, then **More**, **Power On/Preset**, **Power On (Preset)** and **Preset (Factory)**).
- Step 3.** Press the **Preset** key on the NFA and wait for the preset routine to finish.
- Step 4.** Load the noise source ENR calibration file from diskette (A:) or from the NFA's internal memory (C:). Alternatively, create an ENR file from the data supplied on the noise source label (refer to the *Noise Figure Analyzers NFA Series User's Guide* for more details). Do not calibrate the source. The NFA should display **Uncorrected** in the active window.
- Step 5.** Configure the NFA as follows:
1. Set the measured result to Noise Figure (press the **Result** key, then **Noise Figure**).
 2. Select a single graphical display of Noise Figure (press the  key).
 3. Set sweep to single (press the **Sweep** key, then **Sweep Mode: single**).
 4. Set the frequency mode to sweep (press the **Frequency/Points** key, then **Freq Mode** and **Sweep**).
 5. Set the start frequency (press the **Frequency/Points** key, then **Start**, **1**, **0**, **MHz**).

6. Set the stop frequency dependant on the NFA's upper frequency range.

For the N8972A set the stop frequency to 1.5 GHz (press **Stop, 1, ., 5, GHz**)

For the N8973A set the stop frequency to 3.0 GHz (press **Stop, 3, ., 0, GHz**).

For the N8974A set the stop frequency to 6.7 GHz (press **Stop, 6, ., 7, GHz**).

For the N8975A set the stop frequency to 26.5 GHz (press **Stop, 2, 6,., 5, GHz**).

7. Set the number of measured points to 401 (press the **Frequency/Points** key, then **More, Points, 4, 0, 1, Enter**).

Step 6. Models N8974A and N8975A only: run the Yig Tuned Filter alignment by pressing **System, Alignment** and **Align YTF** then wait for the alignment routine to complete.

Step 7. Restart the NFA sweep by pressing the **Restart** key.

Step 8. Once the single sweep is complete set the NFA to autorange (press the **Scale** key and the **Autoscale** menu item).

Step 9. Set the specification limit lines as follows:

1. Press the **Limit Lines** key, then **Limit Line 1** \uparrow , **Type Upper** and **Editor**.
2. Set the first frequency to 10 MHz and the limit to 4.425dB, connected to **Yes** by default (press **1, 0, MHz, [—>], 4, ., 4, 2, 5, Enter** or **X1**).
3. Dependant on the NFA being tested, repeat 2. for the remaining frequencies and limits as detailed in Figure 2-22 thru Figure 2-25.

Test Descriptions
Instrument Noise Figure

Figure 2-22 Specification limit line setup for N8972A

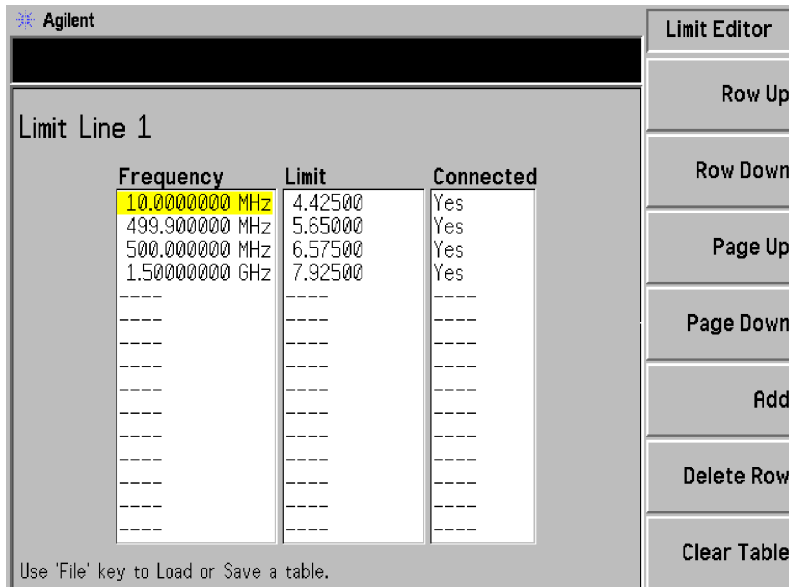

Frequency	Limit	Connected
10.0000000 MHz	4.42500	Yes
499.9000000 MHz	5.65000	Yes
500.0000000 MHz	6.57500	Yes
1.500000000 GHz	7.92500	Yes
----	----	----
----	----	----
----	----	----
----	----	----
----	----	----
----	----	----
----	----	----
----	----	----

Figure 2-23 Specification limit line setup for N8973A

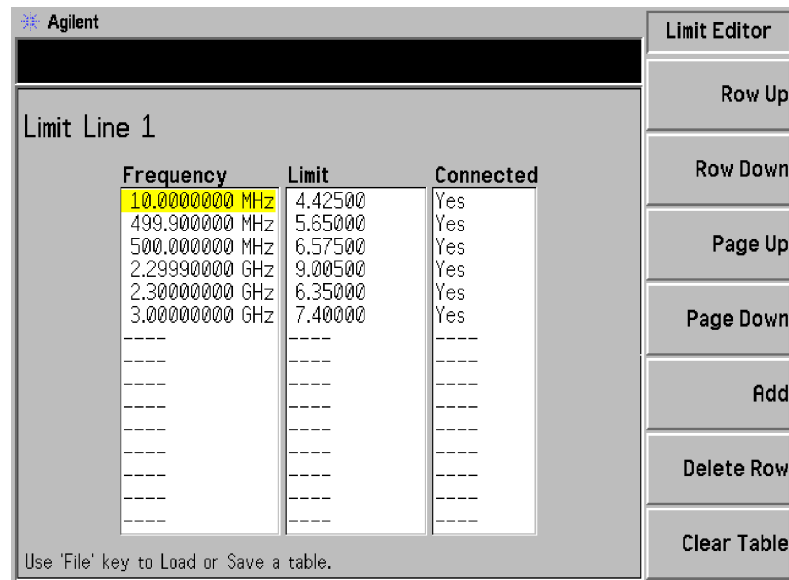

Frequency	Limit	Connected
10.0000000 MHz	4.42500	Yes
499.9000000 MHz	5.65000	Yes
500.0000000 MHz	6.57500	Yes
2.299900000 GHz	9.00500	Yes
2.300000000 GHz	6.35000	Yes
3.000000000 GHz	7.40000	Yes
----	----	----
----	----	----
----	----	----
----	----	----
----	----	----
----	----	----

Figure 2-24 Specification limit line setup for N8974A

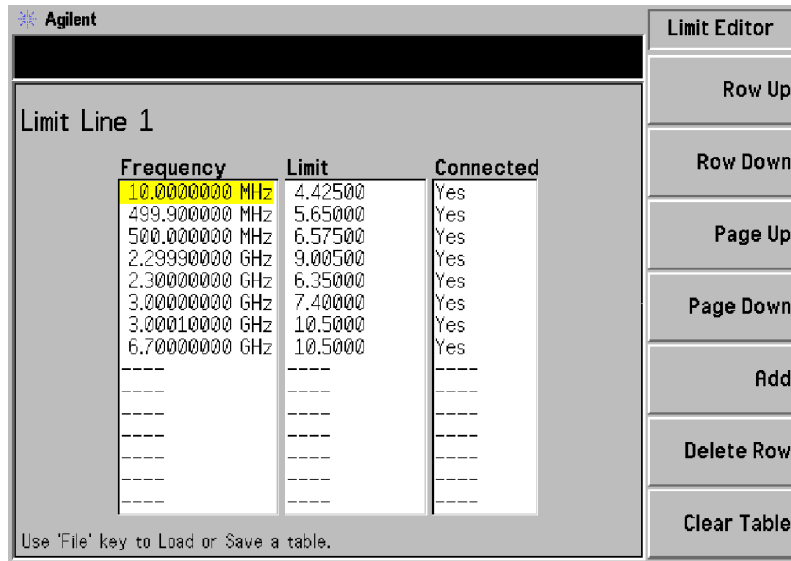

Frequency	Limit	Connected
10.0000000 MHz	4.42500	Yes
499.9000000 MHz	5.65000	Yes
500.0000000 MHz	6.57500	Yes
2.299900000 GHz	9.00500	Yes
2.300000000 GHz	6.35000	Yes
3.000000000 GHz	7.40000	Yes
3.000100000 GHz	10.5000	Yes
6.700000000 GHz	10.5000	Yes
----	----	----
----	----	----
----	----	----
----	----	----
----	----	----

Use 'File' key to Load or Save a table.

Figure 2-25 Specification limit line setup for N8975A

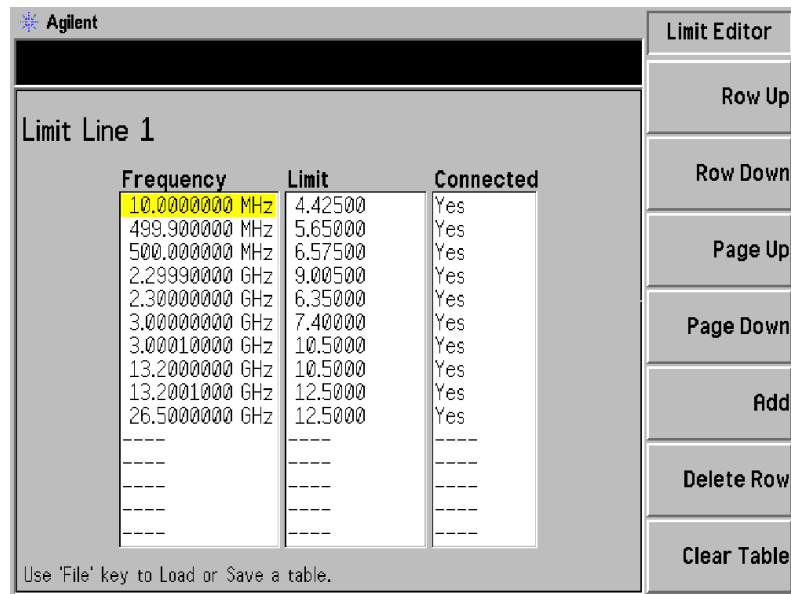

Frequency	Limit	Connected
10.0000000 MHz	4.42500	Yes
499.9000000 MHz	5.65000	Yes
500.0000000 MHz	6.57500	Yes
2.299900000 GHz	9.00500	Yes
2.300000000 GHz	6.35000	Yes
3.000000000 GHz	7.40000	Yes
3.000100000 GHz	10.5000	Yes
13.200000000 GHz	10.5000	Yes
13.200100000 GHz	12.5000	Yes
26.500000000 GHz	12.5000	Yes
----	----	----
----	----	----
----	----	----
----	----	----
----	----	----

Use 'File' key to Load or Save a table.

4. Display the limit line on the screen (press ←Prev key and then Display On).

Test Descriptions
Instrument Noise Figure

- Step 10.** Ensure the trace is below the limit line and enter the overall pass/fail result within the Test Record.
- Step 11.** Complete the Test Record by entering values at fixed frequency points on the trace. These values are purely for reference to the historical data, alternatively the screen could be saved to disk and archived, printed etc.
- Step 12.** Activate the markers function on the analyzer (press the **Marker** key and the **Marker 1, State** and **Normal** menu items).
- Step 13.** Set the marker readout to 10 MHz, the first frequency with the Test Record. Press **1, 0, MHz** and enter the marker value in the Test Record beside the corresponding frequency point.
- Step 14.** Repeat step 12 and step 13 for the remaining frequency points within the Test Record, recording the marker reading at each point and ensuring that the measured points are within the published specifications.

Measurement Jitter

Test Description

A noise source is connected to the NFA's input. The Analyzer then measures linear Y-Factor over 100 samples. The standard deviation is then calculated using the "non-biased" or "n-1" method. STDEV uses the following formula:

Equation 2-2

$$\sigma = \sqrt{\frac{n \sum x^2 - (\sum x)^2}{n(n-1)}}$$

The linear value is then converted to Log10 to give the Y-factor Standard Deviation with no averaging.

Test Specification

Jitter with no averaging: Y-factor Standard Deviation <0.10dB

Related Adjustment

None

Required Test Equipment

Table 2-22 Required equipment for Instrument Measurement Jitter Test

Equipment description	Critical specification for equipment substitution	Recommended model
Noise source	Frequency Range: 1 GHz Typical ENR: 4 - 7dB Connection: 3.5 mm(M) or N Type(M)	346A Standard or option 001
Adapter	3.5 mm Precision (F) to 3.5 mm(F)	83059B
BNC cable	Length 122 cm (48 in.), Frequency 10 MHz	10503A

Test Setup

Figure 2-26 Measurement Jitter Test Setup

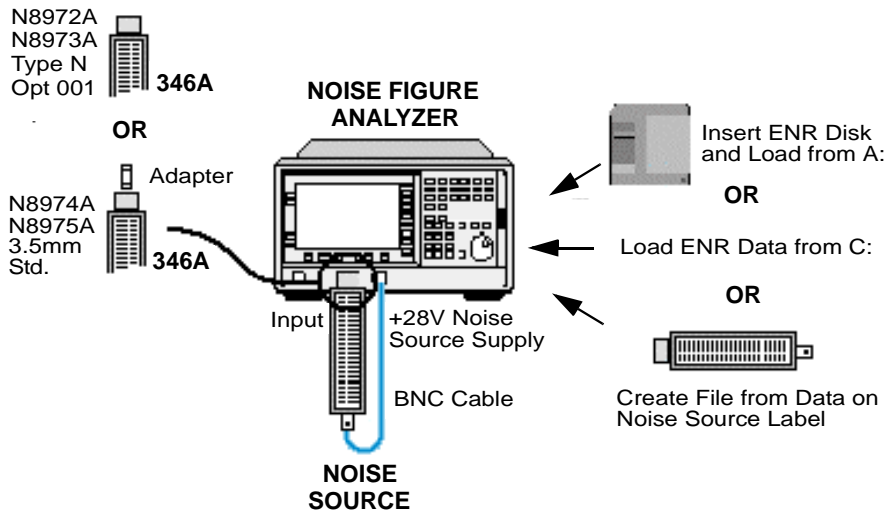

Test Procedure

NOTE

Throughout the Measurement Jitter Test Procedure the term 'the Worksheet' refers to the Measurement Jitter Test Worksheet on page 87. The term 'the Test Record' refers to the Measurement Jitter Test Record detailed in the relevant model number Appendix for the being tested.

- Step 1.** Connect the equipment as shown in Figure 2-26.
- Step 2.** Ensure the preset is set to factory settings (press the **System** key, then **More**, **Power On/Preset**, **Power On (Preset)** and **Preset (Factory)**).
- Step 3.** Press the **Preset** key on the NFA and wait for the routine to finish.
- Step 4.** Load the noise source diskette (A:) or from the NFA's internal memory (C:). Alternatively, create an ENR file from the data supplied on the noise source label (refer to the *Noise Figure Analyzers NFA Series User's Guide*) for more details). Do not calibrate the source. The NFA should display **Uncorrected** in the active window.
- Step 5.** Set the NFA as follows:
1. Set the measure result to Y-Factor (press the **Result** key, then **Y-Factor**).
 2. Set sweep to single (press the **Sweep** key, then **Sweep Mode: single**).
 3. Set the frequency mode to fixed (press the **Frequency/Points** key, then **Freq Mode** and **Fixed**).
 4. Set the fixed frequency to 1 GHz (press **Frequency/Points**, **Fixed Freq**, **1**, **GHz**).
 5. Set measure to Linear mode (press the **Scale** key, then **Units Linear**).
 6. Select the display to meter mode (press the **Format** key, then **Format** and **Meter**).
- Step 6.** Restart the NFA sweep (press the **Restart** key).
- Step 7.** Repeat step 6, recording 100 displayed linear Y-Factor values within the Worksheet.
- Step 8.** Calculate the linear standard deviation with the equation given below:

Test Descriptions
Measurement Jitter

Equation 2-3

$$\sigma = \sqrt{\frac{n \sum x^2 - (\sum x)^2}{n(n-1)}}$$

where n = number of samples, Σ = sum, x = measured values

Using an example result of approximately 2.5, the standard deviation_{Lin} can be calculated as follows.

$$\begin{aligned} \sigma &= \sqrt{100 * \text{sum}(\text{value 1 to } 100^2) - (\text{sum value 1 to } 100)^2 / 100(100-1)} \\ &= \sqrt{100 * 638.3963 - 63838.4147 / 9900} \\ &= \sqrt{0.000123} \\ &= 0.011071_{\text{Lin}} \end{aligned}$$

Table 2-23 Example worksheet

Y-Factor Reading (Lin)	Y-Factor Reading (L
1-10	11-20
2.51173	2.53236
2.52119	2.52459
2.53333	2.52733
2.50778	2.50358
2.51997	2.52640
2.53139	2.52554
2.51906	2.53011
2.49573	2.51576
2.52075	2.54708
2.53547	2.53010

Y-Factor Reading (Lin)	Y-Factor Reading (Lin)
81-90	91-100
2.51882	2.54814
2.52375	2.51989
2.54246	2.52309
2.52668	2.52371
2.53861	2.53395
2.53976	2.54141
2.54001	2.52784
2.54133	2.50001
2.54232	2.54418
2.55278	2.52636

Step 9. Convert the linear standard deviation to Log₁₀ using

$$10 * \text{LOG}_{10} (1 + \text{standard deviation}_{\text{Lin}})$$

to give the standard deviation for Y-Factor results with no Averaging.
 Enter the result into the Test Record ensuring that the measured value is within its published specification.

Example:

$$\begin{aligned} \text{Standard Deviation} &= 10 * \text{LOG}_{10} (1 + \text{standard deviation}_{\text{Lin}}) \\ &= 10 * \text{LOG}_{10} (1 + 0.011071_{\text{Lin}}) \\ &= 0.0478\text{dB} \end{aligned}$$

Table 2-24 Measurement Jitter Test Worksheet

Y-Factor Reading (Lin)	Y-Factor Reading (Lin)	Y-Factor Reading (Lin)	Y-Factor Reading (Lin)	Y-Factor Reading (Lin)	Y-Factor Reading (Lin)	Y-Factor Reading (Lin)	Y-Factor Reading (Lin)	Y-Factor Reading (Lin)	Y-Factor Reading (Lin)
1-10	11-20	21-30	31-40	41-50	51-60	61-70	71-80	81-90	91-100

Test Descriptions
Measurement Jitter

3 Technical Specifications

Specifications apply over 0° C to +55° C unless otherwise stated. The Noise Figure Analyzer meets specification after 2 hours storage within the operating temperature range, 1 hour after the analyzer is turned on with **ALIGNMENT** running.

Frequency

Frequency Range¹	N8972A	10 MHz to 1.5 GHz
	N8973A	10 MHz to 3 GHz
	N8974A	10 MHz to 6.7 GHz
	N8975A	10 MHz to 26.5 GHz
Measurement Bandwidth (nominal)	N8972A	4 MHz
	N8973/4/5A	4 MHz, 2 MHz, 1 MHz, 400 KHz, 200 KHz, 100 KHz
Frequency Reference²		

	Standard	Opt. 1D5^a
Aging	< ±2 ppm ^b /year	< ±1 ppm/year
Temperature Stability	< ±6 ppm	< ±0.01 ppm
Settability	< ±0.5 ppm	< ±0.01 ppm

a. Option 1D5 is recommended for applications requiring high frequency stability.

b. ppm = parts per million(10^{-6})

1. The N8974A and N8975A NFA models have a mechanical switch fitted to allow them to switch between the 10 MHz to 3.0 GHz frequency range and the 3.0 GHz to 6.7 GHz and the 3.0 GHz to 26.5 GHz frequency ranges respectively. If the frequency range you are working in crosses the 3.0 GHz point, the mechanical switch operates. The mechanical switch has a limited number of cycles over which it is reliable. To maximize the switches reliable life, switching over the 3.0 GHz switch should be limited where possible.
2. Temperature stability on the Standard Frequency reference is achieved 60 minutes after the Analyzer is powered on.

**Tuning Accuracy
(Start, Stop,
Centre, Marker)**

Frequency (MHz)	Temperature (0°C - 55°C)
At measurement bandwidth of 4 MHz	
10 - 3000	± Reference error + 100 kHz
> 3000 - 26500	± Reference error + 400 kHz
At measurement bandwidth of < 4 MHz	
10 - 3000	± Reference error + 20 kHz
> 3000 - 26500	± Reference error + 20% of measurement bandwidth

Noise Figure and Gain

Performance is dependent on the ENR¹ of the noise source used:

N8972A		Noise Source ENR		
		4 - 7 dB	12 - 17 dB	20 - 22 dB
Noise Figure	Measurement Range	0 to 20 dB	0 to 30 dB	0 to 35 dB
	Instrument Uncertainty	$\pm < 0.1$ dB	$\pm < 0.1$ dB	$\pm < 0.15$ dB
Gain	Measurement Range	-20 to +40 dB		
	Instrument Uncertainty	$\pm < 0.17$ dB		

N8973A		Noise Source ENR		
		4 - 7 dB	12 - 17 dB	20 - 22 dB
Noise Figure	Measurement Range	0 to 20 dB	0 to 30 dB	0 to 35 dB
	Instrument Uncertainty	$\pm < 0.05$ dB	$\pm < 0.05$ dB	$\pm < 0.1$ dB
Gain	Measurement Range	-20 to +40 dB		
	Instrument Uncertainty ^a	$\pm < 0.17$ dB		

- a. For measurement bandwidths below 4 MHz, and spacing between measurement points below 3 MHz, gain uncertainty may increase to a maximum of ± 0.7 dB.

1. Excess Noise Ratio

N8974A, N8975A (< 3.0 GHz)		Noise Source ENR		
		4 - 7 dB	12 - 17 dB	20 - 22 dB
Noise Figure	Measurement Range	0 to 20 dB	0 to 30 dB	0 to 35 dB
	Instrument Uncertainty	$\pm < 0.05$ dB	$\pm < 0.05$ dB	$\pm < 0.15$ dB
Gain	Measurement Range	-20 to +40 dB		
	Instrument Uncertainty ^a	$\pm < 0.17$ dB		

a. For measurement bandwidths below 4 MHz, and spacing between measurement points below 3 MHz, gain uncertainty may increase to a maximum of ± 0.7 dB.

N8974A, N8975A (> 3.0 - 26.5 GHz)		Noise Source ENR		
		4 - 7 dB	12 - 17 dB	20 - 22 dB
Noise Figure	Measurement Range	0 to 20 dB	0 to 30 dB	0 to 35 dB
	Instrument Uncertainty	$\pm < 0.15$ dB	$\pm < 0.15$ dB	$\pm < 0.2$ dB
Gain	Measurement Range	-20 to +40 dB		
	Instrument Uncertainty ^a	$\pm < 0.17$ dB		

a. For measurement bandwidths below 4 MHz, and spacing between measurement points below 3 MHz, gain uncertainty may increase to a maximum of ± 0.7 dB.

Technical Specifications
Noise Figure and Gain

**Instrument's own
Noise Figure**

Frequency	Noise Figure	Noise Figure over a limited temperature range of 23° C ± 3° C
10 MHz to < 500 MHz	< 4.9 dB + (0.0025 * freq in MHz)	< 4.4 dB + (0.0025 * freq in MHz)
500 MHz to < 2.3 GHz	< 7.4 dB +(0.00135 * freq in MHz)	< 5.9 dB + (0.00135 * freq in MHz)
2.3 GHz to 3.0 GHz	4.9 dB + (0.0015 * freq in MHz)	< 2.9 dB + (0.0015 * freq in MHz)
> 3.0 GHz to 13.2 GHz	< 12.0 dB	< 10.5 dB
>13.2 GHz to 26.5 GHz	< 16.0 dB	< 12.5 dB

Figure 3-1 Characteristic¹ Noise Figure at 23°C ± 3°C (10 MHz to 3.0 GHz)

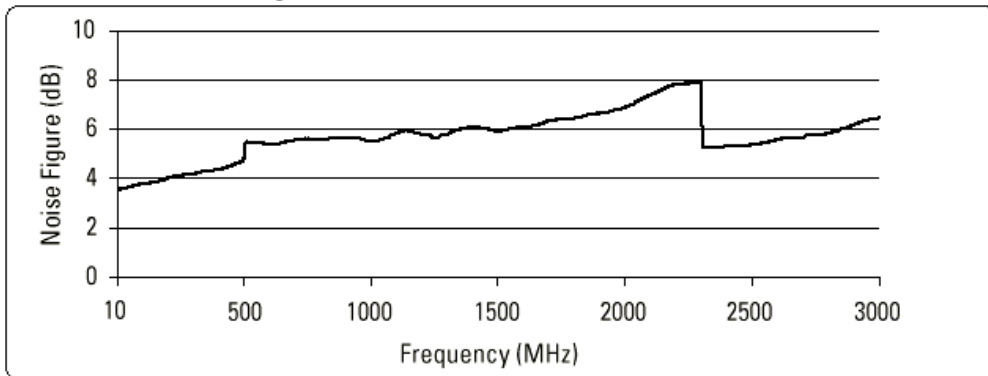

1. Characteristic values are met or improved on by 90% of instruments with 90% confidence.

Figure 3-2 Characteristic¹ Noise Figure at 23°C ± 3°C (3.0 GHz to 26.5 GHz)

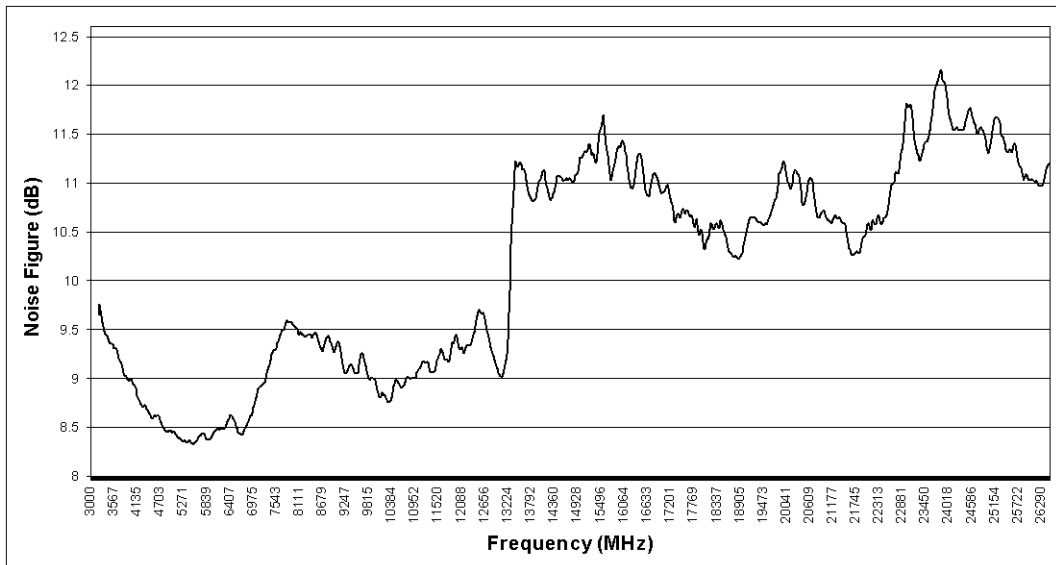

Max external gain >65 dB
between noise
source output and
RF input²

Averaging Up to 999 measurement results

Jitter^{3,4} Jitter with no averaging 5 dB Y-factor standard deviation <0.15 dB

1. Characteristic values are met or improved on by 90% of instruments with 90% confidence.
2. Subject to maximum operating input power
3. Specified for a 4 MHz measurement bandwidth. Jitter in noise figure is equivalent to jitter in Y-factor to within 10% for ENR >14dB and F <4dB. At minimum smoothing, jitter can limit accuracy; the small jitter at high smoothing does not.
4. For true Gaussian noise, jitter reduces with increased averaging, typically by a factor of $1/\sqrt{\text{(number of averages)}}$

RF Input

Connector N8972/3A N female, 50Ω nominal
 N8974/5A APC 3.5 mm, 50Ω nominal (ESD sensitive)

**SWR (50 Ω
reference)**

	10 MHz to 500 MHz	500 MHz to 1.0 GHz	1.0 GHz to 1.5 GHz	1.5 GHz to 3.0 GHz	3.0 GHz to 6.7 GHz	6.7 GHz to 20.0 GHz	20.0 GHz to 26.5 GHz
SWR	< 1.6:1	< 1.8:1	< 1.9:1	< 1.8:1	< 1.3:1	< 2.1:1	< 2.4:1

Figure 3-3 Characteristic¹ SWR at 23° C (10.0 MHz to 3.0 GHz)

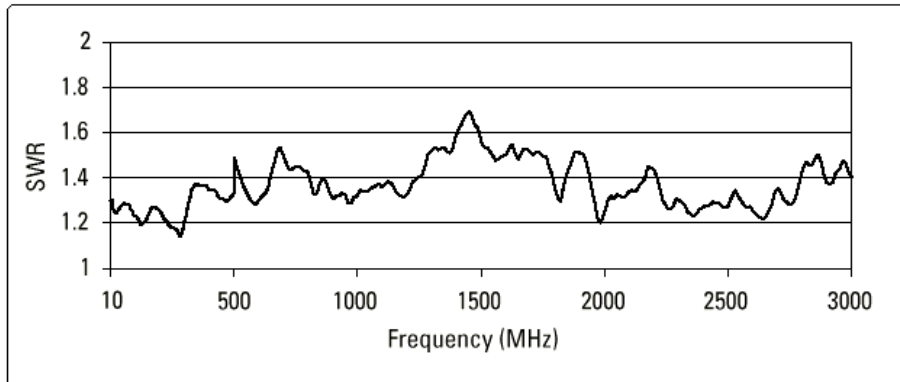

1. Characteristic values are met or improved on by 90% of instruments with 90% confidence.

Figure 3-4 Characteristic¹ SWR at 23° C (3.0 GHz to 26.5 GHz)

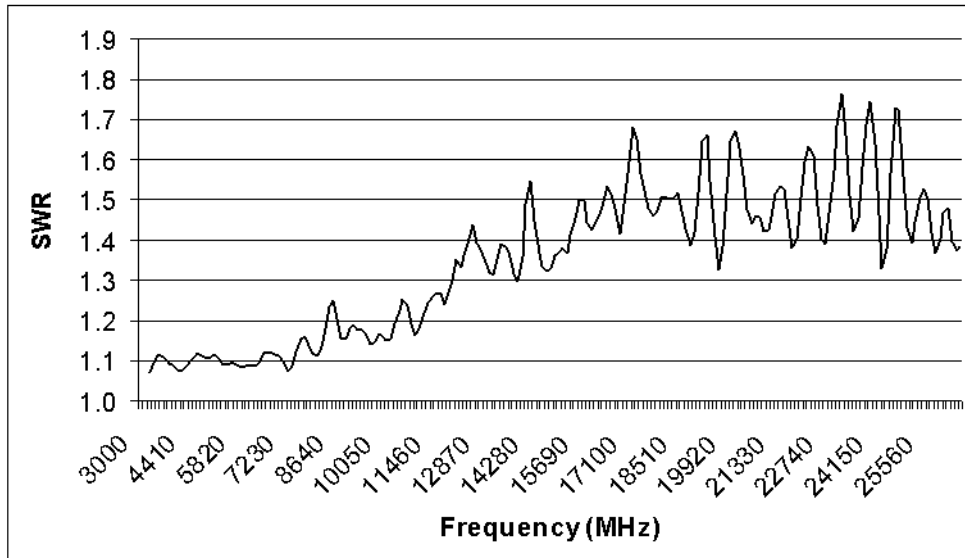

Maximum Operating Input Power²

-10 dBm

Note that this is the total wide-band noise power. Contributing factors are: Noise source ENR, external gain, noise figure, and bandwidth (including DUT).

Maximum Protected Input Level

±20Vdc; +15 dBm peak (or average) at RF

1. Characteristic values are met or improved on by 90% of instruments with 90% confidence.
2. This is the total wide-band noise power. Contributing factors are: Noise Source ENR, external gain, noise figure and bandwidth (including DUT).

Measurement

Sweep

Number of points	2 to 401, or fixed frequency
Setting	Start/Stop, Center/Span, Frequency list of up to 401 points
Sweep trigger	Continuous or Single

Measurement Speed (nominal)^{1,2}

	8 averages	64 averages
N8972A¹	< 100 ms/measurement	< 80 ms/measurement
N8973A¹	< 50 ms/measurement	< 42 ms/measurement
N8974A¹ (≤ 3.0GHz)	< 50 ms/measurement	< 42 ms/measurement
N8975A¹ (≤ 3.0GHz)	< 50 ms/measurement	< 42 ms/measurement
N8974A² (> 3.0GHz)	< 70 ms/measurement	< 50 ms/measurement
N8975A² (> 3.0GHz)	< 70 ms/measurement	< 50 ms/measurement

1. Corrected Noise Figure and Gain measured on a 3dB pad with a repetitive sweep of 101 points from 600 MHz to 1.0 GHz with 4 MHz measurement bandwidth.
2. Corrected noise figure and gain measured on a 3 dB pad with a repetitive sweep of 101 points from 4 GHz to 6 GHz with a 4 MHz measurement bandwidth.

Modes

Amplifier

Downconverter in DUT With fixed or variable IF
Instrument can control an external LO via dedicated 'LO GPIB' connector

Upconverter in DUT With fixed or variable IF
Instrument can control an external LO via dedicated 'LO GPIB' connector

System downconverter Allows the use of an external downconverting mixer as part of the measurement system. Instrument can control an external LO via dedicated 'LO GPIB' connector

Loss compensation Single value between noise source and DUT, and between DUT and analyzer

SNS Series Noise Source ENR tables automatic upload. Continuous upload of T_{cold} .

Display

Type	17cm color LCD panel
Output format	Graphical, table of values, or meter mode
Display channels	2
Number of markers	4
Limit lines	Upper and lower for each of 2 channels

Display units

Noise figure	Noise figure (F dB), or as a ratio (F)
Gain	Gain (G dB), or as a ratio (G)
Y-factor	Y-factor (Y dB) or as a ratio (Y)
Effective noise temperature	Effective input noise temperature in Kelvin, °C, °F
Phot	Relative power density in dB or as a ratio
Pcold	Relative power density in dB or as a ratio

Connectivity

General

GPIB	IEEE-488 bus connector
LO GPIB	IEEE-488 bus connector dedicated to local oscillator control (SCPI or custom command set)
Serial	RS-232, 9-pin D-SUB male
Printer	25-pin parallel D-Sub female, for connection with IEEE 1284 cable to a PCL3 or PCL5 compatible printer
VGA Output¹	15-pin mini D-SUB female
Probe Power (nominal)	+15 Vdc, -12.6 Vdc at 150 mA max.
10 MHz REF OUT	50 Ω nominal BNC (f), >0 dBm
10 MHz REF IN	50 Ω nominal BNC (f), -15 to +10 dBm

Noise Source Drive Output

Connector	50 Ω -type BNC (f)
Output Voltage	ON: 28.0 V \pm 0.1 V at up to 60mA peak OFF: <1 V

1. 31.5 KHz horizontal, 60 Hz vertical sync rates, non-interlaced, Analog RGB 640 x 480

General Specifications

Data Storage (nominal)	Internal drive: 30 traces, states or ENR tables Floppy disk: 30 traces, states or ENR tables
Power Requirements	On (line 1): 90 to 132 V rms, 47 to 440 Hz 195 to 250 V rms, 47 to 66 Hz Power consumption <300 W Standby (line 0): <5 W
Dimensions	Without handle: 222mm(H) x 410mm(D) x 375mm(W) With handle (max): 222mm(H) x 515mm(D) x 409mm(W)
Weight (typical, without options)	N8972A: 15.3 kg (33.7 lbs.) N8973A: 15.5 kg (34.2 lbs.) N8974A: 17.5 kg (38.6 lbs.) N8975A: 17.5 kg (38.6 lbs.)
Audible Noise	<42 dBa pressure and <5.0 bels power (ISODP7779)
Temperature Range	Operating: 0° C to +55° C Storage: -40° C to +70° C
Humidity Range	Operating Up to 95% relative humidity to 40° C (non-condensing)
Altitude Range	Operating to 4,600 meters
Calibration interval	1-year minimum recommended

Electromagnetic Compatibility	<p>This product conforms with the protection requirements of European Council Directive 89/336/EEC for Electromagnetic Compatibility (EMC).</p> <p>The conformity assessment requirements have been met using the technical Construction file route to compliance, using EMC test specifications EN 55011:1991 (Group 1, Class A) and EN 50082-1:1992.</p> <p>In order to preserve the EMC performance of the product, any cable which becomes worn or damaged must be replaced with the same type and specification.</p>
Radio-Frequency Electromagnetic Field Immunity	<p>When a 3 Vm-1 radio-frequency electromagnetic field is applied to the Noise Figure Analyzer according to IEC 61000-4-3:1995, degradation of performance may be observed. When the frequency of the incident field matches the frequency of a measured noise figure or gain, the values displayed will deviate from those expected. This phenomenon will only affect that specific frequency, and the Analyzer will continue to perform to specification at all other frequency sample points.</p> <p>The Noise Figure Analyzer may be unable to calibrate a chosen frequency sample point, if the frequency matches that of an incident electromagnetic field.¹</p>

1. Radiated Immunity Testing. When tested at 3 V/m, according to IEC 801-3/1984, the displayed average noise level will be within specifications over the full immunity test frequency range of 27 MHz to 500 MHz except at the immunity test frequencies of 223.5714 MHz \pm selected resolution bandwidth, and 437.1429 MHz \pm selected resolution bandwidth, where the displayed average noise level can be up to -45 dBm. When the Noise Figure Analyzer tuned frequency is identical to these immunity test frequencies, the measurements could be corrupted and there may be signals of up to -70 dBm displayed on the screen.

A Model N8972A: Test Records

This appendix provides test records for you to photocopy and use when working through each calibration and performance verification test on model N8972A.

10MHz Out Frequency Reference Accuracy Test Record

Standard results:

Description	Measured Frequency (Hz)	Specification (Hz)	Pass/Fail
Frequency Accuracy		$\pm 20\text{Hz}$	
Settability		$\pm 5\text{Hz}$	

Option 1D5 results:

Description	Measured Frequency (Hz)	Specification (Hz)	Pass/Fail
Frequency Reference Accuracy		$\pm 1\text{Hz}$	
Settability		$\pm 0.1\text{Hz}$	

Input VSWR Test Record

Measured Frequency Range	Frequency at Max Measured VSWR	Maximum Measured VSWR	Specification	Pass/Fail
10MHz to 500MHz			$\leq 1.6:1$	
500MHz to 1000MHz			$\leq 1.8:1$	
1000MHz to 1500MHz			$\leq 1.9:1$	

Model N8972A: Test Records
Frequency Accuracy Test Record

Frequency Accuracy Test Record

Frequency (MHz)	Frequency Span (MHz)	Selected Bandwidth (MHz)	Resolution (MHz)	Measured Center Frequency (MHz)	Specification	Pass/Fail
14.00	8.00	4.00	± 10 kHz		± 100 kHz + x	
30.00	8.00	4.00	± 10 kHz		± 100 kHz + x	
60.00	8.00	4.00	± 10 kHz		± 100 kHz + x	
100.00	8.00	4.00	± 10 kHz		± 100 kHz + x	
300.00	8.00	4.00	± 10 kHz		± 100 kHz + x	
600.00	8.00	4.00	± 10 kHz		± 100 kHz + x	
1000.00	8.00	4.00	± 10 kHz		± 100 kHz + x	
1496.00	8.00	4.00	± 10 kHz		± 100 kHz + x	

Where X is equal to the Tuned Frequency * (1 ± Frequency Standard in use)

Noise Source Supply Accuracy Test Record

Noise Source Supply	Measured Voltage (V)	Specification (V)	Pass/Fail
Off		< 1.0 V	
On		< $\pm 0.1V$	

Noise Figure Range and Accuracy Test Record

Results: 4.5 - 6.5dB Noise Source ENR

Input Level (dBm)	Range (dB)	Actual NF (dB)	Measured NF (dB)	Noise Figure Measurement Range (dB)	Instrument Uncertainty (dB)	Specification (dB)	Pass/Fail
----	0.125					± 0.10dB	
----	0.5					± 0.10dB	
-55	1					± 0.10dB	
-56	2			0 - 20 dB		± 0.10dB	
-57	3					± 0.10dB	
-58	4					± 0.10dB	
-59	5					± 0.10dB	
-60	6					± 0.10dB	

Results: 14 - 17dB Noise Source ENR

Input Level (dBm)	Range (dB)	Actual NF (dB)	Measured NF (dB)	Noise Figure Measurement Range (dB)	Instrument Uncertainty (dB)	Specification (dB)	Pass/Fail
----	0.125					± 0.10dB	
----	0.5					± 0.10dB	
-55	1					± 0.10dB	
-56	2					± 0.10dB	
-57	3					± 0.10dB	
-58	4					± 0.10dB	
-59	5			0 - 30 dB		± 0.10dB	
-60	6					± 0.10dB	
-61	7					± 0.10dB	
-62	8					± 0.10dB	
-63	9					± 0.10dB	
-64	10					± 0.10dB	
-65	11					± 0.10dB	
-66	12					± 0.10dB	
-67	13					± 0.10dB	
-68	14					± 0.10dB	
-69	15					± 0.10dB	

Model N8972A: Test Records
Noise Figure Range and Accuracy Test Record

Results: 20 - 22dB Noise Source ENR

Input Level (dBm)	Range (dB)	Actual NF (dB)	Measured NF (dB)	Noise Figure Measurement Range (dB)	Instrument Uncertainty (dB)	Specification (dB)	Pass/Fail
-----	0.125					± 0.15dB	
-----	0.5					± 0.15dB	
-55	1					± 0.15dB	
-56	2					± 0.15dB	
-57	3					± 0.15dB	
-58	4					± 0.15dB	
-59	5					± 0.15dB	
-60	6					± 0.15dB	
-61	7					± 0.15dB	
-62	8					± 0.15dB	
-63	9					± 0.15dB	
-64	10			0 - 35 dB		± 0.15dB	
-65	11					± 0.15dB	
-66	12					± 0.15dB	
-67	13					± 0.15dB	
-68	14					± 0.15dB	
-69	15					± 0.15dB	
-70	16					± 0.15dB	
-71	17					± 0.15dB	
-72	18					± 0.15dB	
-73	19					± 0.15dB	
-74	20					± 0.15dB	
-75	21					± 0.15dB	
-76	22					± 0.15dB	

Gain Measurement Uncertainty Test Record

Measurement Range (dB)	Worst Pk-Pk Instrumentation Uncertainty	Specification (dB)	Pass/Fail
-20 to > +40 dB		± 0.17 dB	

Model N8972A: Test Records
Instrument Noise Figure Test Record

Instrument Noise Figure Test Record

Frequency (MHz)	Instrument Noise Figure (dB)	Specification (dB)	Pass/Fail
10.00 to 1500	Overall Frequency Range Result	Test Line Limit	
10.00		< 4.425dB	
30.00		< 4.475dB	
60.00		< 4.550dB	
100.00		< 4.650dB	
300.00		< 5.150dB	
600.00		< 6.710dB	
1000.00		< 7.250dB	
1500.00		< 7.925dB	

Measurement Jitter Test Record

Frequency (MHz)	Standard Deviation (dB)	Specification (dB)	Pass/Fail
1000		< 0.15dB	

Model N8972A: Test Records
Measurement Jitter Test Record

B **Model N8973A: Test Records**

This appendix provides test records for you to photocopy and use when working through each calibration and performance verification test on model N8973A.

10MHz Out Frequency Reference Accuracy Test Record

Standard results:

Description	Measured Frequency (Hz)	Specification (Hz)	Pass/Fail
Frequency Accuracy		$\pm 20\text{Hz}$	
Settability		$\pm 5\text{Hz}$	

Option 1D5 results:

Description	Measured Frequency (Hz)	Specification (Hz)	Pass/Fail
Frequency Reference Accuracy		$\pm 1\text{Hz}$	
Settability		$\pm 0.1\text{Hz}$	

Input VSWR Test Record

Measured Frequency Range	Frequency at Max Measured VSWR	Maximum Measured VSWR	Specification	Pass/Fail
10MHz to 500MHz			$\leq 1.6:1$	
500MHz to 1000MHz			$\leq 1.8:1$	
1000MHz to 1500MHz			$\leq 1.9:1$	
1500MHz to 3000 Hz			$\leq 1.8:1$	

Model N8973A: Test Records
Frequency Accuracy Test Record

Frequency Accuracy Test Record

Frequency (MHz)	Frequency Span (MHz)	Selected Bandwidth (MHz)	Resolution (MHz)	Measured Center Frequency (MHz)	Specification	Pass/Fail
14.00	8.00	4.00	± 10 kHz		± 100 kHz + x	
30.00	8.00	4.00	± 10 kHz		± 100 kHz + x	
60.00	8.00	4.00	± 10 kHz		± 100 kHz + x	
100.00	8.00	4.00	± 10 kHz		± 100 kHz + x	
300.00	8.00	4.00	± 10 kHz		± 100 kHz + x	
600.00	8.00	4.00	± 10 kHz		± 100 kHz + x	
1000.00	8.00	4.00	± 10 kHz		± 100 kHz + x	
1500.00	8.00	4.00	± 10 kHz		± 100 kHz + x	
2000.00	8.00	4.00	± 10 kHz		± 100 kHz + x	
2996.00	8.00	4.00	± 10 kHz		± 100 kHz + x	
Frequency (MHz)	Frequency Span (MHz)	Selected Bandwidth (MHz)	Resolution (MHz)	Measured Center Frequency (MHz)	Specification	Pass/Fail
1000.00	2.00	0.10	± 5 kHz		± 20 kHz + x	

Where X is equal to the Tuned Frequency * (1 ± Frequency Standard in use)

Noise Source Supply Accuracy Test Record

Noise Source Supply	Measured Voltage (V)	Specification (V)	Pass/Fail
Off		< 1.0 V	
On		< $\pm 0.1V$	

Noise Figure Range and Accuracy Test Record

Results: 4.5 - 6.5dB Noise Source ENR

Input Level (dBm)	Range (dB)	Actual NF (dB)	Measured NF (dB)	Noise Figure Measurement Range (dB)	Instrument Uncertainty (dB)	Specification (dB)	Pass/Fail
-----	0.125					± 0.05dB	
-----	0.5					± 0.05dB	
-55	1					± 0.05dB	
-56	2			0 - 20 dB		± 0.05dB	
-57	3					± 0.05dB	
-58	4					± 0.05dB	
-59	5					± 0.05dB	
-60	6					± 0.05dB	

Results: 14 - 17dB Noise Source ENR

Input Level (dBm)	Range (dB)	Actual NF (dB)	Measured NF (dB)	Noise Figure Measurement Range (dB)	Instrument Uncertainty (dB)	Specification (dB)	Pass /Fail
----	0.125					± 0.05dB	
----	0.5					± 0.05dB	
-55	1					± 0.05dB	
-56	2					± 0.05dB	
-57	3					± 0.05dB	
-58	4					± 0.05dB	
-59	5			0 - 30 dB		± 0.05dB	
-60	6					± 0.05dB	
-61	7					± 0.05dB	
-62	8					± 0.05dB	
-63	9					± 0.05dB	
-64	10					± 0.05dB	
-65	11					± 0.05dB	
-66	12					± 0.05dB	
-67	13					± 0.05dB	
-68	14					± 0.05dB	
-69	15				± 0.05dB		

Model N8973A: Test Records
Noise Figure Range and Accuracy Test Record

Results: 20 - 22dB Noise Source ENR

Input Level (dBm)	Range (dB)	Actual NF (dB)	Measured NF (dB)	Noise Figure Measurement Range (dB)	Instrument Uncertainty (dB)	Specification (dB)	Pass /Fail
-----	0.125					± 0.10dB	
-----	0.5					± 0.10dB	
-55	1					± 0.10dB	
-56	2					± 0.10dB	
-57	3					± 0.10dB	
-58	4					± 0.10dB	
-59	5					± 0.10dB	
-60	6					± 0.10dB	
-61	7					± 0.10dB	
-62	8					± 0.10dB	
-63	9					± 0.10dB	
-64	10			0 - 35 dB		± 0.10dB	
-65	11					± 0.10dB	
-66	12					± 0.10dB	
-67	13					± 0.10dB	
-68	14					± 0.10dB	
-69	15					± 0.10dB	
-70	16					± 0.10dB	
-71	17					± 0.10dB	
-72	18					± 0.10dB	
-73	19					± 0.10dB	
-74	20					± 0.10dB	
-75	21					± 0.10dB	
-76	22					± 0.10dB	

Gain Measurement Uncertainty Test Record

Measurement Range (dB)	Worst Pk-Pk Instrumentation Uncertainty	Specification (dB)	Pass/Fail
-20 to > +40 dB		± 0.17 dB	

Model N8973A: Test Records
Instrument Noise Figure Test Record

Instrument Noise Figure Test Record

Frequency (MHz)	Instrument Noise Figure (dB)	Specification (dB)	Pass/Fail
10.00 to 3000	Overall Frequency Range Result	Test Line Limit	
10.00		< 4.425dB	
30.00		< 4.475dB	
60.00		< 4.550dB	
100.00		< 4.650dB	
300.00		< 5.150dB	
600.00		< 6.710dB	
1000.00		< 7.250dB	
1500.00		< 7.925dB	
2000.00		< 8.600dB	
3000.00		< 7.400dB	

Measurement Jitter Test Record

Frequency (MHz)	Standard Deviation (dB)	Specification (dB)	Pass/Fail
1000		< 0.10dB	

Model N8973A: Test Records
Measurement Jitter Test Record

C Model N8974A: Test Records

This appendix provides test records for you to photocopy and use when working through each calibration and performance verification test on model N8974A.

10MHz Out Frequency Reference Accuracy Test Record

Standard results:

Description	Measured Frequency (Hz)	Specification (Hz)	Pass/Fail
Frequency Accuracy		$\pm 20\text{Hz}$	
Settability		$\pm 5\text{Hz}$	

Option 1D5 results:

Description	Measured Frequency (Hz)	Specification (Hz)	Pass/Fail
Frequency Reference Accuracy		$\pm 1\text{Hz}$	
Settability		$\pm 0.1\text{Hz}$	

Input VSWR Test Record

Measured Frequency Range	Frequency at Max Measured VSWR	Maximum Measured VSWR	Specification	Pass/Fail
10MHz to 500MHz			$\leq 1.6:1$	
500MHz to 1000MHz			$\leq 1.8:1$	
1000MHz to 1500MHz			$\leq 1.9:1$	
1500MHz to 3000MHz			$\leq 1.8:1$	
3000MHz to 6700MHz			$\leq 1.3:1$	

Model N8974A: Test Records
Frequency Accuracy Test Record

Frequency Accuracy Test Record

Frequency (MHz)	Frequency Span (MHz)	Selected Bandwidth (MHz)	Resolution (MHz)	Measured Center Frequency (MHz)	Specification	Pass/Fail
14.00	8.00	4.00	± 10 kHz		± 100 kHz + x	
30.00	8.00	4.00	± 10 kHz		± 100 kHz + x	
60.00	8.00	4.00	± 10 kHz		± 100 kHz + x	
100.00	8.00	4.00	± 10 kHz		± 100 kHz + x	
300.00	8.00	4.00	± 10 kHz		± 100 kHz + x	
600.00	8.00	4.00	± 10 kHz		± 100 kHz + x	
1000.00	8.00	4.00	± 10 kHz		± 100 kHz + x	
1500.00	8.00	4.00	± 10 kHz		± 100 kHz + x	
2000.00	8.00	4.00	± 10 kHz		± 100 kHz + x	
4000.00	8.00	4.00	± 10 kHz		± 400 kHz + x	
5000.00	8.00	4.00	± 10 kHz		± 400 kHz + x	
6000.00	8.00	4.00	± 10 kHz		± 400 kHz + x	
6696.00	8.00	4.00	± 10 kHz		± 400 kHz + x	
Frequency (MHz)	Frequency Span (MHz)	Selected Bandwidth (MHz)	Resolution (MHz)	Measured Center Frequency (MHz)	Specification	Pass/Fail
1000.00	2.00	0.10	± 5 kHz		± 20 kHz + x	

Where X is equal to the Tuned Frequency * (1 ± Frequency Standard in use)

Noise Source Supply Accuracy Test Record

Noise Source Supply	Measured Voltage (V)	Specification (V)	Pass/Fail
Off		< 1.0 V	
On		< $\pm 0.1V$	

Noise Figure Range and Accuracy Test Record

Results: 4.5 - 6.5dB Noise Source ENR

Input Level (dBm)	Range (dB)	Actual NF (dB)	Measured NF (dB)	Noise Figure Measurement Range (dB)	Instrument Uncertainty (dB)	Specification (dB)	Pass/Fail
----	0.125					± 0.05dB	
----	0.5					± 0.05dB	
-55	1					± 0.05dB	
-56	2			0 - 20 dB		± 0.05dB	
-57	3					± 0.05dB	
-58	4					± 0.05dB	
-59	5					± 0.05dB	
-60	6					± 0.05dB	

Results: 14 - 17dB Noise Source ENR

Input Level (dBm)	Range (dB)	Actual NF (dB)	Measured NF (dB)	Noise Figure Measurement Range (dB)	Instrument Uncertainty (dB)	Specification (dB)	Pass/Fail
----	0.125					± 0.05dB	
----	0.5					± 0.05dB	
-55	1					± 0.05dB	
-56	2					± 0.05dB	
-57	3					± 0.05dB	
-58	4					± 0.05dB	
-59	5			0 - 30 dB		± 0.05dB	
-60	6					± 0.05dB	
-61	7					± 0.05dB	
-62	8					± 0.05dB	
-63	9					± 0.05dB	
-64	10					± 0.05dB	
-65	11					± 0.05dB	
-66	12					± 0.05dB	
-67	13					± 0.05dB	
-68	14					± 0.05dB	
-69	15					± 0.05dB	

Model N8974A: Test Records
Noise Figure Range and Accuracy Test Record

Results: 20 - 22dB Noise Source ENR

Input Level (dBm)	Range (dB)	Actual NF (dB)	Measure d NF (dB)	Noise Figure Measurement Range (dB)	Instrument Uncertainty (dB)	Specification (dB)	Pass/Fail
-----	0.125					± 0.10dB	
-----	0.5					± 0.10dB	
-55	1					± 0.10dB	
-56	2					± 0.10dB	
-57	3					± 0.10dB	
-58	4					± 0.10dB	
-59	5					± 0.10dB	
-60	6					± 0.10dB	
-61	7					± 0.10dB	
-62	8					± 0.10dB	
-63	9					± 0.10dB	
-64	10			0 - 35 dB		± 0.10dB	
-65	11					± 0.10dB	
-66	12					± 0.10dB	
-67	13					± 0.10dB	
-68	14					± 0.10dB	
-69	15					± 0.10dB	
-70	16					± 0.10dB	
-71	17					± 0.10dB	
-72	18					± 0.10dB	
-73	19					± 0.10dB	
-74	20					± 0.10dB	
-75	21					± 0.10dB	
-76	22					± 0.10dB	

Gain Measurement Uncertainty Test Record

Measurement Range (dB)	Worst Pk-Pk Instrumentation Uncertainty	Specification (dB)	Pass/Fail
-20 to > +40 dB		± 0.17 dB	

Model N8974A: Test Records
Instrument Noise Figure Test Record

Instrument Noise Figure Test Record

Frequency (MHz)	Instrument Noise Figure (dB)	Specification (dB)	Pass/Fail
10.00 to 6700	Overall Frequency Range Result	Test Line Limit	
10.00		< 4.425dB	
30.00		< 4.475dB	
60.00		< 4.550dB	
100.00		< 4.650dB	
300.00		< 5.150dB	
600.00		< 6.710dB	
1000.00		< 7.250dB	
1500.00		< 7.925dB	
2000.00		< 8.600dB	
3000.00		<7.400dB	
4000.00		< 10.50dB	
5000.00		< 10.50dB	
6000.00		< 10.50dB	
6700.00		< 10.50dB	

Measurement Jitter Test Record

Frequency (MHz)	Standard Deviation (dB)	Specification (dB)	Pass/Fail
1000		< 0.10dB	

Model N8974A: Test Records
Measurement Jitter Test Record

D **Model N8975A: Test Records**

This appendix provides test records for you to photocopy and use when working through each calibration and performance verification test on model N8975A.

10MHz Out Frequency Reference Accuracy Test Record

Standard results:

Description	Measured Frequency (Hz)	Specification (Hz)	Pass/Fail
Frequency Accuracy		$\pm 20\text{Hz}$	
Settability		$\pm 5\text{Hz}$	

Option 1D5 results:

Description	Measured Frequency (Hz)	Specification (Hz)	Pass/Fail
Frequency Reference Accuracy		$\pm 1\text{Hz}$	
Settability		$\pm 0.1\text{Hz}$	

Input VSWR Test Record

Measured Frequency Range	Frequency at Max Measured VSWR	Maximum Measured VSWR	Specification	Pass/Fail
10MHz to 500MHz			$\leq 1.6:1$	
500MHz to 1000MHz			$\leq 1.8:1$	
1000MHz to 1500MHz			$\leq 1.9:1$	
1500MHz to 3000MHz			$\leq 1.8:1$	
3000MHz to 6700MHz			$\leq 1.3:1$	
6700MHz to 20000MHz			$\leq 2.1:1$	
20000MHz to 26500MHz			$\leq 2.4:1$	

Model N8975A: Test Records
Frequency Accuracy Test Record

Frequency Accuracy Test Record

Frequency (MHz)	Frequency Span (MHz)	Selected Bandwidth (MHz)	Resolution (MHz)	Measured Center Frequency (MHz)	Specification	Pass/Fail
14.00	8.00	4.00	± 10 kHz		± 100 kHz + x	
30.00	8.00	4.00	± 10 kHz		± 100 kHz + x	
60.00	8.00	4.00	± 10 kHz		± 100 kHz + x	
100.00	8.00	4.00	± 10 kHz		± 100 kHz + x	
300.00	8.00	4.00	± 10 kHz		± 100 kHz + x	
600.00	8.00	4.00	± 10 kHz		± 100 kHz + x	
1000.00	8.00	4.00	± 10 kHz		± 100 kHz + x	
1500.00	8.00	4.00	± 10 kHz		± 100 kHz + x	
2000.00	8.00	4.00	± 10 kHz		± 100 kHz + x	
4000.00	8.00	4.00	± 10 kHz		± 400 kHz + x	
5000.00	8.00	4.00	± 10 kHz		± 400 kHz + x	
6000.00	8.00	4.00	± 10 kHz		± 400 kHz + x	
7000.00	8.00	4.00	± 10 kHz		± 400 kHz + x	
8000.00	8.00	4.00	± 10 kHz		± 400 kHz + x	
9000.00	8.00	4.00	± 10 kHz		± 400 kHz + x	
10000.00	8.00	4.00	± 10 kHz		± 400 kHz + x	
11000.00	8.00	4.00	± 10 kHz		± 400 kHz + x	
12000.00	8.00	4.00	± 10 kHz		± 400 kHz + x	
13000.00	8.00	4.00	± 10 kHz		± 400 kHz + x	
14000.00	8.00	4.00	± 10 kHz		± 400 kHz + x	

Model N8975A: Test Records
Frequency Accuracy Test Record

Frequency (MHz)	Frequency Span (MHz)	Selected Bandwidth (MHz)	Resolution (MHz)	Measured Center Frequency (MHz)	Specification	Pass/Fail
15000.00	8.00	4.00	± 10 kHz		± 400 kHz + x	
16000.00	8.00	4.00	± 10 kHz		± 400 kHz + x	
17000.00	8.00	4.00	± 10 kHz		± 400 kHz + x	
18000.00	8.00	4.00	± 10 kHz		± 400 kHz + x	
19000.00	8.00	4.00	± 10 kHz		± 400 kHz + x	
20000.00	8.00	4.00	± 10 kHz		± 400 kHz + x	
21000.00	8.00	4.00	± 10 kHz		± 400 kHz + x	
22000.00	8.00	4.00	± 10 kHz		± 400 kHz + x	
23000.00	8.00	4.00	± 10 kHz		± 400 kHz + x	
24000.00	8.00	4.00	± 10 kHz		± 400 kHz + x	
25000.00	8.00	4.00	± 10 kHz		± 400 kHz + x	
26000.00	8.00	4.00	± 10 kHz		± 400 kHz + x	
26496.00	8.00	4.00	± 10 kHz		± 400 kHz + x	
Frequency (MHz)	Frequency Span (MHz)	Selected Bandwidth (MHz)	Resolution (MHz)	Measured Center Frequency (MHz)	Specification	Pass/Fail
1000.00	2.00	0.10	± 5 kHz		± 20 kHz + x	

Where X is equal to the Tuned Frequency * (1 ± Frequency Standard in use)

Model N8975A: Test Records
Noise Source Supply Accuracy Test Record

Noise Source Supply Accuracy Test Record

Noise Source Supply	Measured Voltage (V)	Specification (V)	Pass/Fail
Off		< 1.0 V	
On		< $\pm 0.1V$	

Noise Figure Range and Accuracy Test Record

Results: 4.5 - 6.5dB Noise Source ENR

Input Level (dBm)	Range (dB)	Actual NF (dB)	Measured NF (dB)	Noise Figure Measurement Range (dB)	Instrument Uncertainty (dB)	Specification (dB)	Pass/Fail
----	0.125					± 0.05dB	
----	0.5					± 0.05dB	
-55	1					± 0.05dB	
-56	2			0 - 20 dB		± 0.05dB	
-57	3					± 0.05dB	
-58	4					± 0.05dB	
-59	5					± 0.05dB	
-60	6					± 0.05dB	

Model N8975A: Test Records
Noise Figure Range and Accuracy Test Record

Results: 14 - 17dB Noise Source ENR

Input Level (dBm)	Range (dB)	Actual NF (dB)	Measured NF (dB)	Noise Figure Measurement Range (dB)	Instrument Uncertainty (dB)	Specification (dB)	Pass/Fail
----	0.125					± 0.05dB	
----	0.5					± 0.05dB	
-55	1					± 0.05dB	
-56	2					± 0.05dB	
-57	3					± 0.05dB	
-58	4					± 0.05dB	
-59	5			0 - 30 dB		± 0.05dB	
-60	6					± 0.05dB	
-61	7					± 0.05dB	
-62	8					± 0.05dB	
-63	9					± 0.05dB	
-64	10					± 0.05dB	
-65	11					± 0.05dB	
-66	12					± 0.05dB	
-67	13					± 0.05dB	
-68	14					± 0.05dB	
-69	15					± 0.05dB	

Results: 20 - 22dB Noise Source ENR

Input Level (dBm)	Range (dB)	Actual NF (dB)	Measured NF (dB)	Noise Figure Measurement Range (dB)	Instrument Uncertainty (dB)	Specification (dB)	Pass/Fail
----	0.125					± 0.10dB	
----	0.5					± 0.10dB	
-55	1					± 0.10dB	
-56	2					± 0.10dB	
-57	3					± 0.10dB	
-58	4					± 0.10dB	
-59	5					± 0.10dB	
-60	6					± 0.10dB	
-61	7					± 0.10dB	
-62	8					± 0.10dB	
-63	9					± 0.10dB	
-64	10			0 - 35 dB		± 0.10dB	
-65	11					± 0.10dB	
-66	12					± 0.10dB	
-67	13					± 0.10dB	
-68	14					± 0.10dB	
-69	15					± 0.10dB	
-70	16					± 0.10dB	
-71	17					± 0.10dB	
-72	18					± 0.10dB	
-73	19					± 0.10dB	
-74	20					± 0.10dB	
-75	21					± 0.10dB	
-76	22					± 0.10dB	

Gain Measurement Uncertainty Test Record

Measurement Range (dB)	Worst Pk-Pk Instrumentation Uncertainty	Specification (dB)	Pass/Fail
-20 to > +40 dB		$\pm 0.17\text{dB}$	

Instrument Noise Figure Test Record

Frequency (MHz)	Instrument Noise Figure (dB)	Specification (dB)	Pass/Fail
10.00 to 26500	Overall Frequency Range Result	Test Line Limit	
10.00		< 4.425dB	
30.00		< 4.475dB	
60.00		< 4.550dB	
100.00		< 4.650dB	
300.00		< 5.150dB	
600.00		< 6.710dB	
1000.00		< 7.250dB	
1500.00		< 7.925dB	
2000.00		< 8.600dB	
4000.00		< 7.400dB	
5000.00		< 10.50dB	
6000.00		< 10.50dB	
7000.00		< 10.50dB	
8000.00		< 10.50dB	
9000.00		< 10.50dB	
10000.00		< 10.50dB	
11000.00		< 10.50dB	
12000.00		< 10.50dB	
13000.00		< 10.50dB	

Model N8975A: Test Records
Instrument Noise Figure Test Record

Frequency (MHz)	Instrument Noise Figure (dB)	Specification (dB)	Pass/Fail
14000.00		< 12.50dB	
15000.00		< 12.50dB	
16000.00		< 12.50dB	
17000.00		< 12.50dB	
18000.00		< 12.50dB	
19000.00		< 12.50dB	
20000.00		< 12.50dB	
21000.00		< 12.50dB	
22000.00		< 12.50dB	
23000.00		< 12.50dB	
24000.00		< 12.50dB	
25000.00		< 12.50dB	
26000.00		< 12.50dB	
26500.00		< 12.50dB	

Measurement Jitter Test Record

Frequency (MHz)	Standard Deviation (dB)	Specification (dB)	Pass/Fail
1000		< 0.10dB	

Model N8975A: Test Records

Measurement Jitter Test Record

E **Caring for Connectors**

The material contained in this appendix may not be apply to the connector you are using on the instrument.

Introduction

Recent advances in measurement capabilities have made connectors and connection techniques more important than ever before. Damage to the connectors on calibration and verification devices, test ports, cables, and other devices represent an increasing burden in downtime and expense.

This Appendix will help you get the best performance from all coaxial microwave connectors:

- To know what to look for when cleaning and inspecting them, in order to preserve their precision and extend their life.
- To make the best possible microwave connections, improving the accuracy and repeatability of all of your measurements, saving both time and money.

Connector Part Numbers

Refer to the latest edition of the HP RF and Microwave Test Accessories Catalog for connector part numbers.

Handling and Storage

Microwave connectors must be handled carefully, inspected before use and when not in use, stored in a way that gives them maximum protection. Avoid touching the connector mating plane surfaces and avoid setting the connectors contact-end down, especially on a hard surface.

Never store connectors with the contact end exposed. Plastic end caps are provided with all Agilent connectors and these should be retained after unpacking and placed over the ends of the connectors whenever they are not in use. Extend the threads of connectors that have a retractable sleeve or sliding connector nut, then put the plastic end cap over the end of the connector.

Above all, never store any devices loose in a box or in a desk or a bench drawer. Careless handling of this kind is the most common cause of connector damage during storage.

Visual Inspection

Visual inspection and, if necessary, cleaning should be done every time a connection is made.

Metal and metal by-product particles from the connector threads often find their way onto the mating plane surfaces when a connection is disconnected and even one connection made with a dirty or damaged connector can damage both connectors beyond repair.

Magnification is helpful when inspecting connectors, but it is not required and may actually be misleading. Defects and damage that cannot be seen without magnification generally have no effect on electrical or mechanical performance. Magnification is of great use in analyzing the nature and cause of damage and in cleaning connectors, but it is not required for inspection.

Obvious Defects and Damage

Examine the connectors first for obvious defects or damage: badly worn plating, deformed threads or bent, broken, or misaligned center conductors. Connector nuts should move smoothly and be free of burrs, loose metal particles, and rough spots.

Immediately discard, or mark for identification and send away for repair, any connector that has obvious defects like these.

Mating Plane Surfaces

Flat contact between the connectors at all points on their mating plane surfaces is required for a good connection. Therefore, particular attention should be paid to deep scratches or dents, and to dirt and metal or metal by-product particles on the connector mating plane surfaces.

Also look for bent or rounded edges on the mating plane surfaces of the center and outer conductors and for any signs of damage due to excessive or uneven wear or misalignment.

Visual Inspection

Light burnishing of the mating plane surfaces is normal, and is evident as light scratches or shallow circular marks distributed more or less uniformly over the mating plane surface. Other small defects and cosmetic imperfections are also normal. None of these affect electrical or mechanical performance.

If a connector shows deep scratches or dents, particles clinging to the mating plane surfaces, or uneven wear, clean it and inspect it again. Damage or defects like dents or scratches, which are deep enough to displace metal on the mating plane surface of the connector, may indicate that the connector itself is damaged and should not be used. Try to determine the cause of the damage before making further connections.

Precision 7 mm Connectors

Precision 7mm connectors, among them APC-7[®] connectors, should be inspected visually with the center conductor collets in place, and whenever the collet has been removed. See Figure E-1.

The collet itself should be inspected for edge or surface damage and for any signs that the spring contacts are bent or twisted. If they are, replace the collet. When the collet has been re-inserted, verify that it springs back immediately when pressed with a blunt plastic rod or with the rounded plastic handle of the collet removing tool. Never use a pencil or your finger for this purpose.

Figure E-1

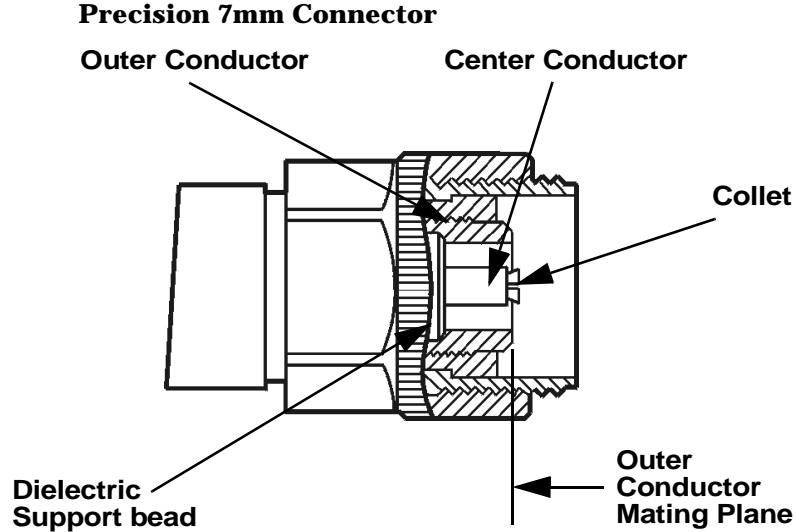

Sexed Connectors

On sexed connectors, especially precision 3.5mm and SMA connectors, pay special attention to the female center conductor contact fingers (Figure E-2 and Figure E-3). These are very easily bent or broken, and damage to them is not always easy to see. Any connector with damaged contact fingers will not make good electrical contact and must be replaced.

Figure E-2

Precision 3.5mm connectors

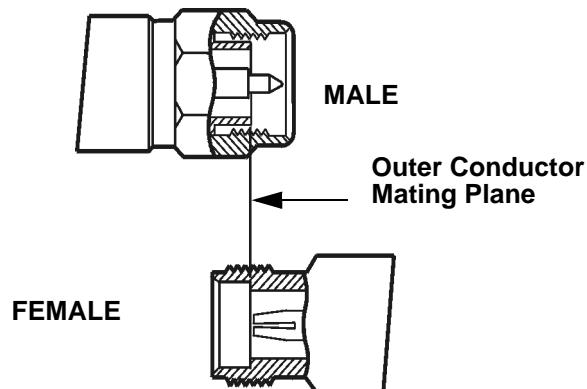
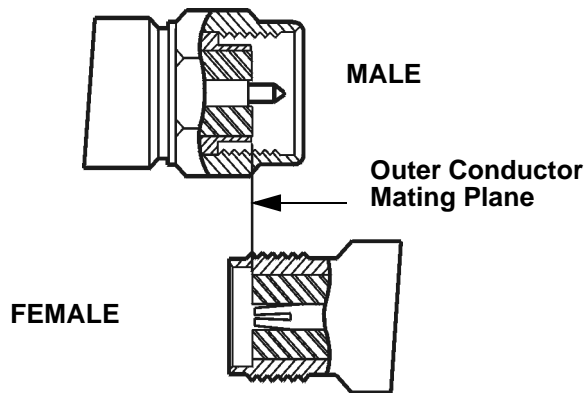

Figure E-3

SMA connectors



Cleaning

Careful cleaning of all connectors is essential to assure long, reliable connector life, to prevent accidental damage to connectors, and to obtain maximum measurement accuracy and repeatability. Yet it is the one step most often neglected or done improperly. Supplies recommended for cleaning microwave connectors are as follows:

- Compressed Air.
- Alcohol.
- Cotton Swabs.
- Lint-Free Cleaning Cloth.

Compressed Air

Loose particles on the connector mating plane surfaces can usually be removed with a quick blast of compressed air. This is very easy to do and should always be tried first using compressed air from a small pressurized can. The stream of air can be directed exactly where it is wanted through a plastic (not metal) nozzle. No hoses or other connections are needed. Hold the can upright, to avoid spraying liquid along with the vapor.

Cleaning Alcohol

Dirt and stubborn contaminants that cannot be removed with compressed air can often be removed with a cotton swab or lint free cleaning cloth moistened with alcohol.

NOTE

Use the least amount of alcohol possible, and avoid wetting any plastic parts in the connectors with the alcohol.

Cleaning

Alcohol should be used in liquid rather than spray form. If a spray must be used, always spray the alcohol onto a cloth or swab, never directly into a connector.

Very dirty connectors can be cleaned with pure alcohol. Other solutions that contain additives should not be used.

Carefully avoid wetting the plastic support bead (which is easily damaged by alcohol) inside the connector and blow the connector dry immediately with a gentle stream of compressed air.

Precision 7 mm Connectors

When precision 7mm connectors have been cleaned with the center conductor collet removed, insert the collet and clean the mating plane surfaces again.

When the connector is attached to a small component, or to a cable, calibration, or verification standard, the easiest way to do this is to put a lint-free cleaning cloth flat on a table and put a couple of drops of alcohol in the center of the cloth. It should be noted that it is not necessary to remove the collet to use this cleaning method.

Retract the connector sleeve threads so that the connector interface is exposed. Gently press the contact end of the connector into the cloth moistened with alcohol, then turn the connector.

Dirt on the connector interface will be scrubbed away by the cloth without damaging the connector. Blow the connector dry with a gentle stream of compressed air.

This cleaning method can be adapted even for fixed connectors such as those attached to test ports. Simply fold the cloth into several layers of thickness, moisten it, press it against the connector interface, and turn it to clean the connector. Blow the connector dry with a gentle stream of compressed air.

Cleaning Interior Surfaces

Interior surfaces, especially on precision 3.5mm connectors, are very difficult to reach, and it is easy to damage connectors in trying to clean them. The openings are very small, and generally the center conductor is supported only at the inner end, by a plastic dielectric support bead. This makes it very easy to bend or break the center conductor.

One suitable method (Figure E-4) is to cut off the sharp tip of a round wooden toothpick, or a smaller diameter wooden rod, and then to wrap it with a single layer of lint-free cleaning cloth.

Figure E-4

Cleaning interior surfaces



NOTE

Metal must never be used (it will scratch the plated surfaces), and in cleaning precision 3.5mm connectors the diameter must not exceed 0.070 in. (1.7 mm). The wooden handle of a cotton swab, for example, is too large for this purpose. Even though the handle can sometimes be inserted into the connector, even when wrapped in lint-free cloth, movement of the handle against the center conductor can exert enough force on the center conductor to damage it severely.

Cleaning

Moisten the cloth with a small amount of alcohol and carefully insert it into the connector to clean the interior surfaces. Use an illuminated magnifying glass or microscope to see clearly the areas you wish to clean.

Drying Connectors

When you have cleaned a connector, always be sure that it is completely dry before reassembling or using it. Blow the connector dry with a gentle stream of clean compressed air and inspect it again under a magnifying glass to be sure that no particles or alcohol residues remain.

Mechanical Inspection: Connector Gages

Even a perfectly clean, unused connector can cause problems if it is mechanically out of specification. Since the critical tolerances in microwave connectors are on the order of a few ten-thousandths of an inch, using a connector gage is essential.

Before using any connector for the first time, inspect it mechanically using a connector gage. How often connectors should be gaged after that depends upon usage.

In general, connectors should be gaged whenever visual inspection or electrical performance suggests that the connector interface may be out of specification, for example due to wear or damage. Connectors on calibration and verification devices should also be gaged whenever they have been used by someone else or on another system or piece of equipment.

Precision 3.5mm and SMA connectors should be gaged relatively more often than other connectors, owing to the ease with which the center pins can be pulled out of specification during disconnection.

Connectors should also be gaged as a matter of routine - after every 100 connections and disconnections initially, more or less often after that as experience suggests.

Table E-1 Recommended connector gages

Connector gage kits containing all of the items required are included in many Agilent calibration kits. They are also available separately. Part numbers are as follows.	
Type	Part Number/Ordering Information
Precision 7mm (APC-7)	85050-80012
Precision 3.5mm	11752D
Precision 2.4mm	11752E
Type-N	85054-60047

Mechanical Specifications

The critical dimension to be measured, regardless of connector type, is the position (generally, the recession or setback) of the center conductor relative to the outer conductor mating plane.

Mechanical specifications for connectors specify a maximum distance and a minimum distance that the center conductor can be positioned behind (or, in female Type-N connectors, in front of) the outer conductor mating plane. Nominal specifications for each connector type exist, but the allowable tolerances (and sometimes the dimensions themselves) differ from manufacturer to manufacturer and from device to device. Therefore, before gaging any connector, consult the mechanical specifications provided with the connector or the device itself.

Precision 7mm Connectors

In precision 7mm connectors, contact between the center conductors is made by spring-loaded contacts called collets. These protrude slightly in front of the outer conductor mating plane when the connectors are apart. When the connection is tightened, the collets are compressed into the same plane as the outer conductors.

For this reason, two mechanical specifications are generally given for precision 7mm connectors: the maximum recession of the center conductor behind the outer conductor mating plane with the center conductor collet removed; and a minimum and maximum allowable protrusion of the center conductor collet in front of the outer conductor mating plane with the collet in place.

The center conductor collet should also spring back immediately when pressed with a blunt plastic rod or with the rounded plastic handle of the collet removing tool. Never use a pencil or your finger for this purpose.

With the center conductor collet removed, no protrusion of the center conductor in front of the outer conductor mating plane is allowable, and sometimes a minimum recession is required. Consult the mechanical specifications provided with the connector or the device itself.

Sexed Connectors

In Type-N and precision 3.5mm connectors, the position of the center conductor in the male connector is defined as the position of the shoulder of the male contact pin - not the position of the tip. The male contact pin slides into the female contact fingers and electrical contact is made by the inside surfaces of the tip of the female contact fingers on the sides of the male contact pin.

50 Ohm Type-N Connectors

NOTE

No Type-N connector should ever be used when there is any possibility of interference between the shoulder of the male contact pin and the tip of the female contact fingers when the connectors are mated. In practice this means that no Type-N connector pair should be mated when the separation between the tip of the female contact fingers and the shoulder of the male contact pin could be less than zero when the connectors are mated. Gage Type-N connectors carefully to avoid damage.

Type-N connectors differ from other connector types in that the outer conductor mating plane is offset from the mating plane of the center conductors. The outer conductor sleeve in the male connector extends in front of the shoulder of the male contact pin. When the connection is made, this outer conductor sleeve fits into a recess in the female outer conductor behind the tip of the female contact fingers (Figure E-5).

Figure E-5

Type-N connectors

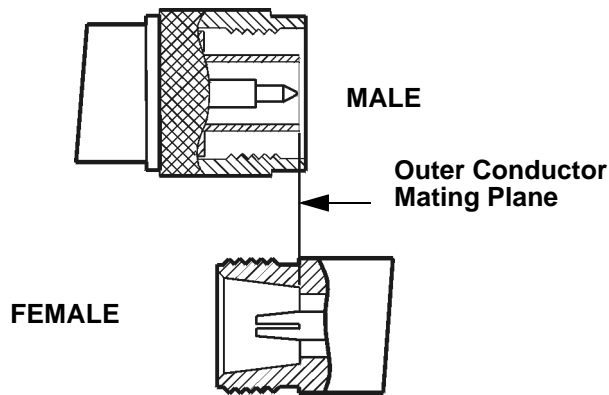

Therefore the mechanical specifications of Type-N connectors give a maximum protrusion of the female contact fingers in front of the outer conductor mating plane and a minimum recession of the shoulder of the male contact pin behind the outer conductor mating plane.

As Type-N connectors wear, the protrusion of the female contact fingers generally increases, due to wear of the outer conductor mating plane inside the female connector. This decreases the total center conductor contact separation and should be monitored carefully.

75 Ohm Type-N Connectors

75 Ω Type-N connectors differ from 50 Ω Type-N connectors most significantly in that the center conductor, male contact pin, and female contact hole are smaller. Therefore, mating a male 50 Ω Type-N connector with a female 75 Ω Type-N connector will destroy the female 75 Ω connector by spreading the female contact fingers apart permanently or even breaking them.

NOTE

If both 75 Ω and 50 Ω Type-N connectors are among those on the devices you are using, identify the 75 Ω Type-N connectors to be sure that they are never mated with any 50 Ω Type-N connectors.

Using Connector Gages

Before a connector gage is used, it must be inspected, cleaned, and zeroed.

Inspecting and Cleaning the Gage

Inspect the connector gage and the gage calibration block carefully, exactly as you have inspected the connector itself. Clean or replace the gage or the block if necessary (dirt on the gage or block will make the gage measurements of the connectors inaccurate and can transfer dirt to the connectors themselves, damaging them during gaging or when the connection is made).

Zeroing the Gage

Zero the gage by following the steps described below. Be sure that you are using the correct connector gage and correct end of the gage calibration block for the connector being measured.

- Hold the gage by the plunger barrel (not the dial housing or cap) and, for male connectors, slip the protruding end of the calibration block into the circular bushing on the connector gage. For precision 7mm, female precision 3.5mm use the flat end of the gage calibration block. For female Type-N connectors, use the recessed end of calibration block.
- Hold the gage by the plunger barrel only (Figure E-6). Doing so will prevent errors in gage readings due to the application of stresses to the gage plunger mechanism through the dial indicator housing.
- Carefully bring the gage and gage block together, applying only enough pressure to the gage and gage block to result in the dial indicator pointer settling at a reading.

Caring for Connectors
Using Connector Gages

- Gently rock the two surfaces together, to make sure that they have come together flatly. The gage pointer should now line up exactly with the zero mark on the gage. If it does not, inspect and clean the gage and gage calibration block again and repeat this process. If the gage pointer still does not line up with the zero mark on the gage, loosen the dial lock screw and turn the graduated dial until the gage pointer exactly lines up with zero. Then retighten the lock screw.

Figure E-6 **Using the connector gage**



NOTE

Gages should be checked often, to make sure that the zero setting has not changed. Generally, when the gage pointer on a gage that has been zeroed recently does not line up exactly with the zero mark, the gage or calibration block needs cleaning. Clean carefully and check the zero setting again.

Measuring Connectors

Measuring the recession of the center conductor behind the outer conductor mating plane in a connector is done in exactly the same way as zeroing the gage, except of course that the graduated dial is not re-set when the measurement is made.

If the connector has a retractable sleeve or sliding connector nut - precision 7mm connectors, for example - extend the sleeve or nut fully. This makes it easier to keep the gage centered in the connector.

Hold the gage by the plunger barrel and slip the gage into the connector so that the gage plunger rests against the center conductor. Carefully bring the gage into firm contact with the outer conductor mating plane.

Apply only enough pressure to the gage so that the gage pointer settles at a reading.

Gently rock the connector gage within the connector, to make sure that the gage and the outer conductor have come together flatly. Read the recession (or protrusion) from the gage dial. (For maximum accuracy, measure the connector several times and take an average of the readings.)

Rotate the gage relative to the connector between each measurement. To monitor connector wear, record the readings for each connector over time.

Making Connections

Making good connections is easy if a few simple principles are kept in mind:

- All connectors must be undamaged, clean, and within mechanical specification.
- The connectors must be precisely aligned with one another and in flat physical contact at all points on the mating plane surfaces.
- The connection must not be too tight or too loose.
- Lateral or horizontal (bending) force must not be applied to the connection, nor should any connection ever be twisted.

Align Connectors Carefully

Careful alignment of the connectors is critical in making a good connection, both to avoid damaging connectors and devices and to assure accurate measurements.

As you bring one connector up to the other and as you make the actual connection, be alert for any sign that the two connectors are not aligned perfectly. If you suspect that misalignment has occurred, stop and begin again.

Alignment is especially important in the case of sexed connectors, such as precision 3.5mm and SMA connectors, to avoid bending or breaking the contact pins. The center pin on the male connector must slip concentrically into the contact fingers of the female connector. This requires great care in aligning the two connectors before and as they are mated.

When they have been aligned, the center conductors must be pushed straight together, not twisted or screwed together, and only the connector nut (not the device itself) should then be rotated to make the connection. (slight resistance is generally felt as the center conductors mate).

Alignment of precision 7mm connectors is made easier by the fact that the connector sleeve on one of the connectors must be extended fully (and the sleeve on the other connector retracted fully) in order to make the connection. Extending the sleeve creates a cylinder into which the other connector fits.

If one of the connectors is fixed, as on a test port, extend that connector sleeve and spin its knurled connector nut to make sure that the threads are fully extended, while on the other connector, fully retract the connector sleeve.

To Make a Preliminary Connection

Align the two connectors carefully and engage the connector nut over the exposed connector sleeve threads on the other connector.

Gently turn the connector nut until a preliminary connection is made. Let the connector nut pull the two connectors straight together. Do not twist one connector body into the other (as you might drive a screw or insert a light bulb) as this is extremely harmful and can damage the connectors.

When the mating plane surfaces make uniform, light contact, the preliminary connection is tight enough. Do not overtighten this connection.

NOTE

At this stage all you want is a connection in which the outer conductors make gentle contact at all points on both mating surfaces. Very light finger pressure (no more than 2 inch-ounces of torque) is enough.

Final Connection Using a Torque Wrench

When the preliminary connection has been made, use a torque wrench to make the final connection. Tighten the connection only until the “break” point of the wrench is reached, when the wrench handle gives way at its internal pivot point. Do not tighten the connection further.

Also make sure that torque actually is being applied to the connection through the torque wrench, not only to the wrench handle or in any way that prevents the break point of the wrench from controlling the torque applied to the connection. Suggestions to ensure that torque is actually being applied are given in Table E-2 on page 175.

Using a torque wrench guarantees that the connection will not be too tight, thus preventing possible damage to the connectors and impaired electrical performance. It also guarantees that all connections will be made with the same degree of tightness every time they are made.

Torque wrenches pre-set to the correct value for each connector type are included in many Agilent calibration kits, and they are also available separately. Torque settings are detailed in Table E-2.

When using a torque wrench, prevent rotation of anything other than the connector nut that is being tightened with the torque wrench. Generally this is easy to do by hand (all the more so if one of the connectors is fixed) as on a test port. In other situations, an open-end wrench can be used to keep the bodies of the connectors from turning.

Hold the torque wrench lightly by the knurled end of the handle only. Apply force at the end of the torque wrench only, perpendicular to the wrench and always in a plane parallel to the outer conductor mating planes. This will result in torque being applied to the connection through the wrench until the break point of the wrench is reached.

Avoid pivoting the wrench handle on the thumb or other fingers. This results in an unknown amount of torque being applied to the connection when the break point of the wrench is reached. Avoid twisting the head of the wrench relative to the outer conductor mating plane. This results in applying more than the recommended torque.

Table E-2 Recommended Torque Settings

Type	Description
Precision 7mm	12 lb-in (136 N-cm.)
Precision 3.5mm	8 lb-in (90 N-cm)
SMA	5 lb-in (56 N-cm) Use the SMA wrench to connect male SMA connectors to female precision 3.5mm connectors. Connections of male precision 3.5mm connectors to female SMA connectors can be made with the precision 3.5mm torque wrench (8 lb-in).
Type-N	Type-N connectors may be connected finger tight. If a torque wrench is used, 12 lb-in (136 N-cm) is recommended.

To reiterate the main do's and do not's detailed previously:

- Avoid holding the wrench tightly, in such a way that the handle is not pivoted but simply pushed downward the same amount throughout its length. If this is done, an unlimited amount of torque can be applied.
- Hold the wrench at the same point near the end of the handle every time, and always in the same orientation. Whenever possible, begin tightening the connection with the wrench held horizontally

Disconnection

Disconnect connectors by first loosening the connector nut that was tightened in order to make the connection. If necessary, use the torque wrench or an open-end wrench to start the process, but leave the connection finger tight. At all times support the devices and the connection to avoid putting lateral (bending) force on the connectors.

Complete the disconnection by disconnecting the connector nut completely.

NOTE

Never disconnect connectors by twisting one connector or device out of the other as one might remove a screw or a light bulb. This is extremely harmful and connector damage can occur whenever the device body rather than the nut alone is being turned.

If the connection is between sexed connectors, pull the connectors straight apart and be especially careful not to twist the body of any device as you do so. Twisting the connection can damage the connector by damaging the center conductors or the interior component parts to which the connectors themselves are attached. It can also scrape the plating from the male contact pin or even (in rare instances) unscrew the male or female contact pin slightly from its interior mounting, bringing it out of specification (this can also occur if the female contact fingers are unusually tight).

Adapters

Adapters are used to connect a device with one connector interface to a device or to test equipment that has another interface, or to reduce wear on connectors that may be difficult or expensive to replace. Reducing wear is possibly the most important use of adapters, especially when devices that have SMA connectors are being used.

SMA connectors are low-cost connectors generally used up to about 23GHz. They are not precision mechanical devices and are not designed for repeated connections and disconnections as they wear out quickly and are very often found, upon assembly, to be out of specification, even before they have been used. This makes them potentially destructive to any precision 3.5mm connectors with which they might be mated.

CAUTION

Worn, damaged, or out-of-specification SMA connectors can destroy a precision 3.5mm connector even on the very first connection. For this reason it is recommended that you use high-quality precision adapters, sometimes called “connector savers”, whenever more than a few connections are to be made between SMA and precision 3.5mm connectors.

In most applications two adapters will be required, one each at the input and the output of the device. Male-female adapters cause no change in the sex of the interface. The same interface is presented when the adapter is in place as is presented in the original setup.

Same-sex adapters (male-male, female-female) change the sex of the interface. For example, if the original interface presents a male connector, attaching a female-female adapter will result in a female interface to which devices or cables that have male SMA (or male precision 3.5mm) connectors can be connected.

Adapters are included in many Agilent calibration kits and with many Agilent devices, or they may be ordered separately.

Caring for Connectors
Adapters

Table E-3 Adapters

Type	Description
Precision 7mm and Type-N	Precision 7mm/male 3.5mm Precision 7mm/female 3.5 mm Precision 7mm/male 50Ω Type-N Precision 7mm/female 50Ω Type-N
Precision 3.5mm and SMA	Male 3.5mm/female 3.5mm Male 3.5mm/female 3.5 mm Female 3.5mm/female 3.5mm Precision 7mm/male 3.5mm Precision 7mm/female 3.5mm “Connector saver” male 3.5mm/female 3.5 mm “Connector saver” male 3.5mm/male 3.5mm

Principles of Microwave Connector Care

Table E-4 Principles of Microwave Connector Care

Handling and Storage	
DO	DO NOT
<ul style="list-style-type: none"> • Keep connectors clean. • Extend sleeve or connector nut. • Use plastic end caps during storage. 	<ul style="list-style-type: none"> • Touch mating plane surfaces. • Set connectors contact-end down.
Visual Inspection	
DO	DO NOT
<ul style="list-style-type: none"> • Inspect each connector carefully before every connection. • Look for metal particles, scratches and dents. 	<ul style="list-style-type: none"> • Use a damaged connector - EVER.
Cleaning	
DO	DO NOT
<ul style="list-style-type: none"> • Try compressed air first. • Clean connector threads. 	<ul style="list-style-type: none"> • Use any abrasives. • Get liquid onto plastic support beads.

Caring for Connectors
Principles of Microwave Connector Care

Table E-4 Principles of Microwave Connector Care

Gaging	
DO	DO NOT
<ul style="list-style-type: none"> • Clean and zero the gage before using. • Use correct gage type. • Use correct end of calibration block. • Gage all connectors before first use. 	<ul style="list-style-type: none"> • Use an out-of-spec connector.
Making Connections	
DO	DO NOT
<ul style="list-style-type: none"> • Align connectors carefully. • Make preliminary connection lightly. • Turn connector nut only to tighten. • Use a torque wrench for final connection. 	<ul style="list-style-type: none"> • Apply bending force to connection. • Overtighten preliminary connection. • Twist or screw in connectors. • Tighten past “break” point of torque wrench.